

Travel Demand Management Plan 170 N. May Street & 175 N. Racine Avenue

Chicago, Illinois



Prepared For:



KLOA
Kenig, Lindgren, O'Hara, Aboona, Inc.

July 10, 2024

Introduction

This report summarizes the results of a Travel Demand Management Plan (TDM plan) prepared by Kenig, Lindgren, O’Hara, Aboona, Inc. (KLOA, Inc.) for the proposed mixed-use development to be located at 170 N. May Street and 175 N. Racine Avenue in Chicago, Illinois.

As proposed, the development will consist of two separate buildings containing a total of 667 residential units, an 18,500 square-foot grocery store, approximately 4,850 square-feet of new ground floor retail, and two parking garages containing a total 505 spaces of which 50 will be exclusively for the use of grocery store customers.

The purpose of the TDM plan is to identify existing pedestrian facilities and alternative modes of transportation serving the area, collect and evaluate data related to the utilization of alternative modes of transportation, and to provide recommendations related to reducing single occupancy vehicle usage as part of the proposed development.

Study Area Characteristics

For the purposes of this TDM plan, the study area consists of the area generally bounded by Fulton Market on the north, Aberdeen Street on the east, Randolph Street on the south, and Racine Avenue on the west. **Figure 1** shows an aerial view of the study area.

The existing land-uses within the vicinity of the site are mixed-use providing residential, office, retail, restaurant and industrial land-uses. As of April 2024, KLOA, Inc. is aware of numerous proposed developments located within the vicinity of the site. The following mixed-used developments are located adjacent to or near the subject development:

- 1234 W. Randolph Street
- 166 N. Aberdeen Street
- 210 N. Aberdeen Street
- 1200 W. Carroll Avenue
- 315 N. May Street
- 160 N. Elizabeth Street
- 1200 W. Fulton Market
- 1251 W. Fulton Market
- 1245 W. Fulton Market
- 1229 W. Randolph Street
- 1201 W. Washington Boulevard

These planned developments will further enhance the mixed-use nature of the study area and will provide pedestrian facility enhancements on their respective frontages.

Existing Pedestrian Facilities

Sidewalks are generally located on both sides of the area streets and crosswalks are generally located at the area intersections. High visibility crosswalks are provided on all legs of the study intersections.

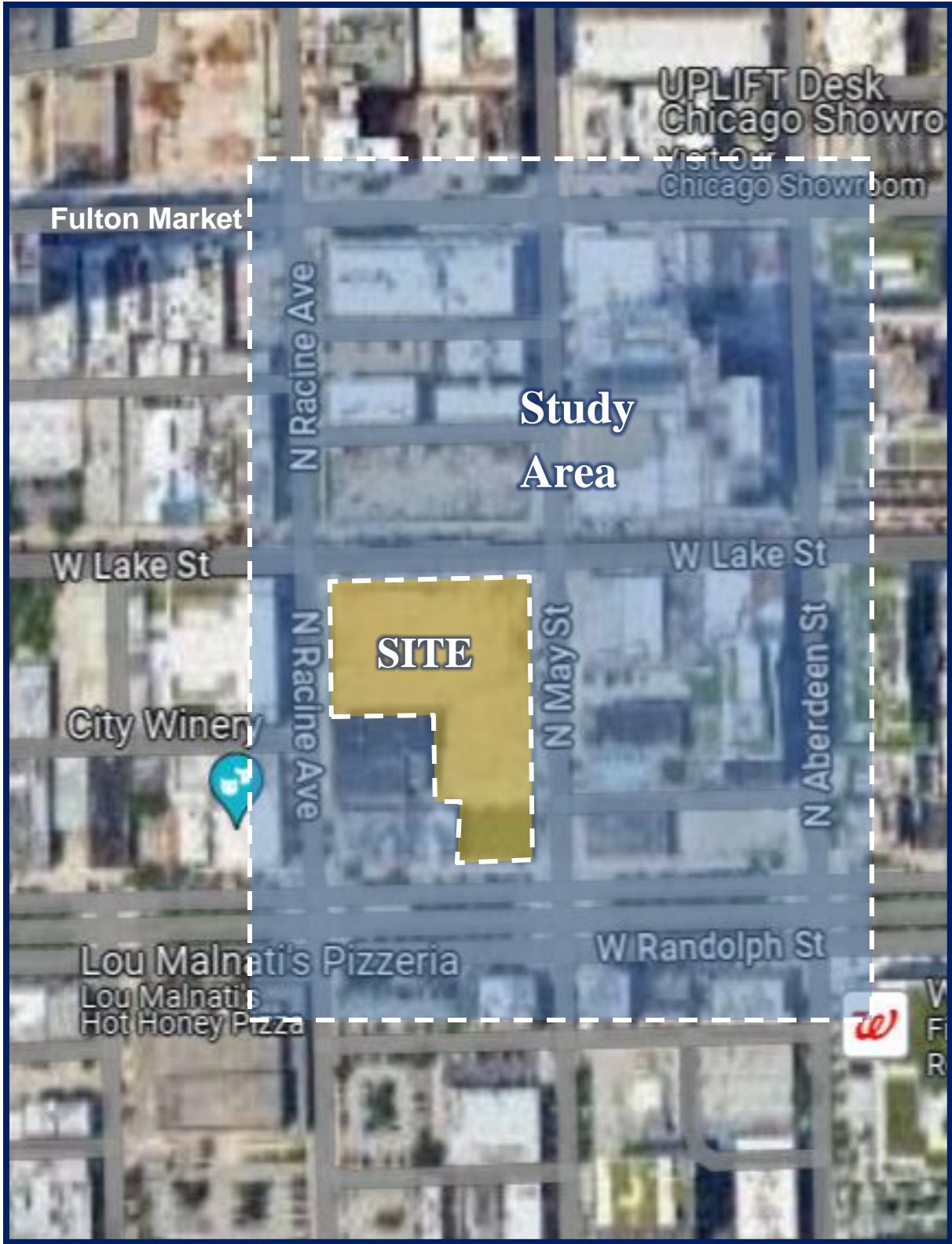

Study Area

Figure 1

170 N. May Street and 175 N. Racine Avenue
Chicago, Illinois



Alternative Modes of Transportation

The public transportation serving the area is summarized below and illustrated in **Figure 2**.

CTA Rapid Transit. The area is served by the Chicago Transit Authority (CTA) rapid transit Green and Pink Lines via the Morgan station located approximately 1,005 feet east of the site. The following summarizes the rapid transit lines serving the area:

- The CTA Green Line operates daily along Lake Street between Harlem Avenue in Forest Park and the downtown Loop and from the downtown Loop to 63rd Street on Chicago's South Side. South of 59th Street, the line branches off to provide service between Cottage Grove Avenue and Ashland Avenue.
- The CTA Pink Line operates daily between 54th Avenue near Cermak Road in Cicero and the downtown Loop.

It should be noted that, according to the *Transit Friendly Development Guide* produced in part by CDOT and the CTA, the area surrounding the Morgan station is considered a Major Activity Center (MC). This classification describes station areas which are intended to be developed at a significant density that supports and provides services for the region and nearby neighborhoods. These areas often provide a balance of residential, retail, and employment uses.

CTA Bus Routes. The area is also served by the following bus routes, all of which have bus stops within a few blocks of the site:

Route 8 (Halsted) runs along Halsted Street between 79th Street and Waveland Avenue. It operates daily, including holidays, from approximately 4:00 A.M. to 12:40 A.M.

Route 19 (United Center Express) operates along Randolph Street and Washington Street for all Bulls and Blackhawks games and other select events at the United Center. Buses typically operate from Michigan Avenue and Randolph Street every 16 minutes starting 90 minutes before an event until the start. After the event, buses operate every few minutes for up to one hour.

Route 20 (Madison) generally runs along Madison Street and Randolph Street between Austin Boulevard and Michigan Avenue. Service is provided seven days a week.

Route 65 (Grand) provides service primarily on Grand Avenue between Streeter Drive at Navy Pier and Nordica Avenue. This route also serves Navy Pier via Grand Avenue (westbound) and Illinois Street (eastbound). Service is generally provided from approximately 5:00 A.M. to 10:00 P.M. seven days a week.

Route 132 (Goose Island Express) runs from Ashland Avenue and Cortland Street and the downtown Loop primarily via Halsted Street weekdays from approximately 6:30 A.M. to 8:30 A.M. and from 3:30 P.M. to 6:00 P.M. Notable stops include the Metra Clybourn station, the North/Clybourn Red Line station, Grand Avenue Blue Line station, Ogilvie Station, Union Station, LaSalle Metra station, and Van Buren Metra station.

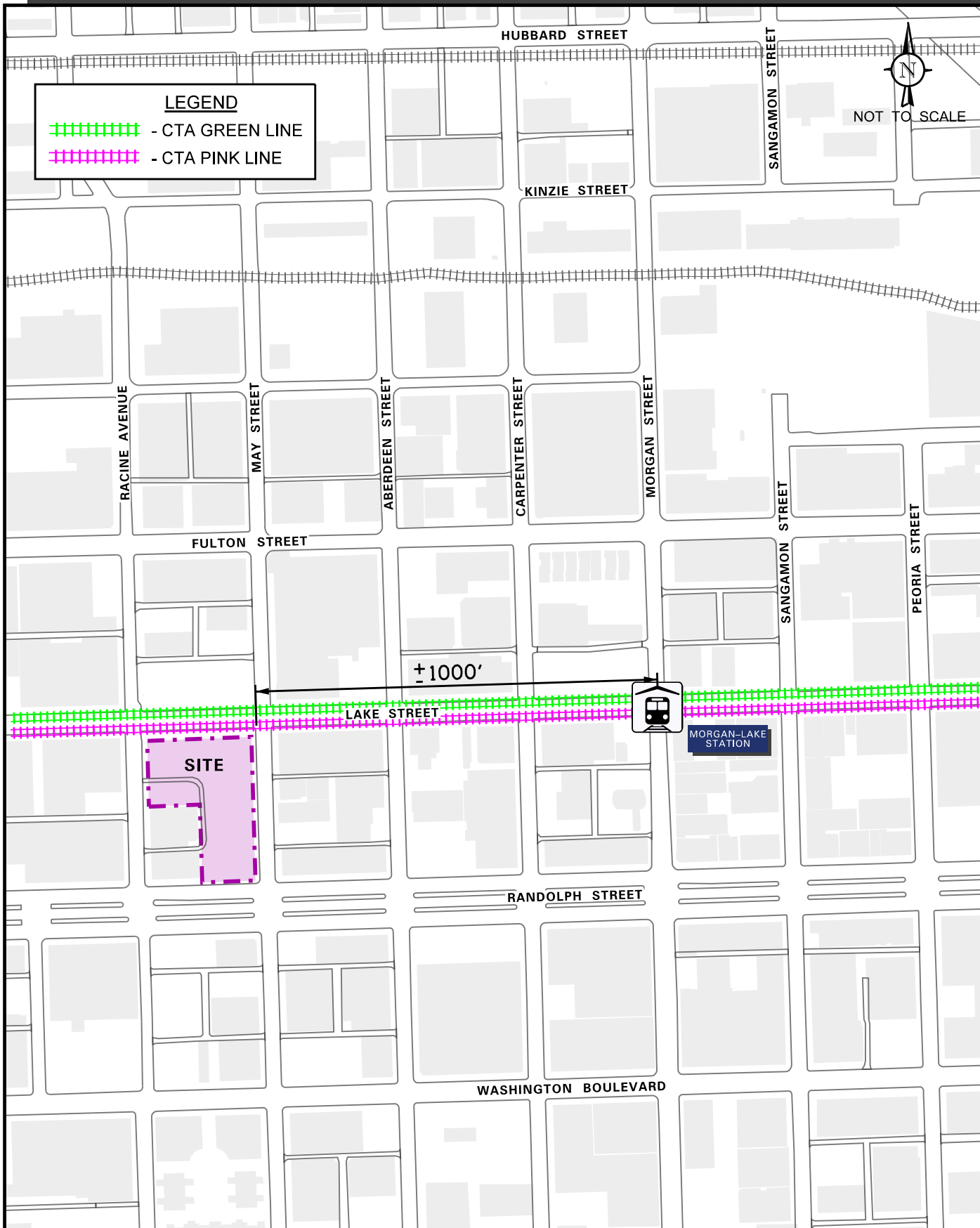

Bike Lanes. Within the vicinity of the study area, buffer-protected bike lanes are provided on Washington Boulevard (eastbound only). Furthermore, Halsted Street is designated as a bike route and provides buffer-protected bike lanes north of Lake Street (according to CDOT, 2016). These streets provide access to/from other bikeways, including Des Plaines Street, Milwaukee Avenue, and Ogden Avenue. According to the City of Chicago's *Streets for Cycling Plan 2020* the following streets in the area are designated bike routes:

- Spoke Route
 - Lake Street (west of Des Plaines Street)
 - Des Plaines Street (north of Randolph Street)
 - Randolph Street (east of Des Plaines Street)

- Crosstown Bike Route
 - Washington Boulevard
 - Randolph Street (west of Des Plaines Street)
 - Des Plaines Street (south of Randolph Street)
 - Halsted Street
 - Adams Street
 - Ogden Avenue

- Neighborhood Bike Route
 - Morgan Street
 - Green Street (between Kinzie Street and Hubbard Street)

Mode-Sharing Transportation Availability. Several Divvy bike sharing stations are located within the area with the closest stations located on the northeast corner of the intersection of Lake Street with Carpenter Street, the southwest corner of the intersection of Lake Street with Morgan Street, the southeast corner of Randolph Street with Aberdeen Street, and the northeast corner of Randolph Street with Racine Avenue. The Lake/Carpenter station provides six bike docks, the Lake/Morgan station provides 20 bike docks and the other two stations provide 15 and 19 bike docks, respectively. In addition, car-sharing is available at a few locations within walking distance of the site, including vehicles near the intersections of Elizabeth Street with Fulton Market.

Carshare Availability. There are currently two Zipcar carsharing vehicles available within the vicinity of the site with one vehicle located at 1330 W. Fulton Market (1330 W. Fulton Market Parking), and one vehicle located at 737 W. Washington Boulevard (Halsted and Washington Garage)

Pedestrian and Bicycle Counts

As part of the traffic impact study prepared by KLOA, Inc. for the proposed development, KLOA, Inc. utilized peak period traffic, pedestrian, and bicycle counts conducted utilizing Miovision Scout Video Collection Units for the following intersections:

- Racine Avenue with Fulton Market
- Racine Avenue with Lake Street
- Racine Avenue with Randolph Street
- Aberdeen Street with Fulton Market
- Aberdeen Street with Lake Street
- May Street with Fulton Market
- May Street with Lake Street
- May Street with Randolph Street

The counts were conducted on weekdays during the weekday morning (7:00 A.M. to 9:00 A.M.) and weekday evening (4:00 P.M. to 7:00 P.M.) peak periods. The results of the traffic counts show that the weekday morning peak hour generally occurs between 8:00 A.M. and 9:00 A.M. and the weekday evening peak hour generally occurs between 5:00 P.M. and 6:00 P.M. **Figure 3** illustrates the existing peak hour pedestrian and bicycle volumes.

Area Census Data

The site is located within one-quarter mile of the Chicago Transit Authority (CTA) rapid transit Green and Pink Lines via the Morgan station and within one-half mile of the CTA rapid transit Green and Pink Lines via the Ashland station. For the purposes of this evaluation, the data encompassing the transit stations and the census tract encompassing the site were utilized. Based on the census data, the following was determined related to means of transportation to work

- Data for the CTA Morgan Station is not currently available. Data for within one-quarter mile of the CTA Ashland Station is provided as the Ashland Station is the next station west of the Morgan Station for both the Pink and Green rapid transit lines.
 - Approximately 16 percent of people utilize public transportation.
 - Approximately 1 percent of people bicycle.
 - Approximately 18 percent of people walk.
 - Approximately 13 percent of people work from home.
- CTA Grand Station (within one-half mile)
 - Approximately 24 percent of people utilize public transportation.
 - Approximately 1 percent of people bicycle.
 - Approximately 24 percent of people walk.
 - Approximately 7 percent of people work from home.
- Census Tract 8330 (American Community Survey 2022 Five Year Estimates)
 - Approximately 25 percent of people drove alone.
 - Approximately 4 percent of people carpooled.
 - Approximately 20 percent of people utilize public transportation to get to work.
 - Approximately 21 percent of people walk.
 - Approximately 6 percent of people utilized a taxicab/motorcycle/bicycle.
 - Approximately 24 percent of people work from home



NOT TO SCALE

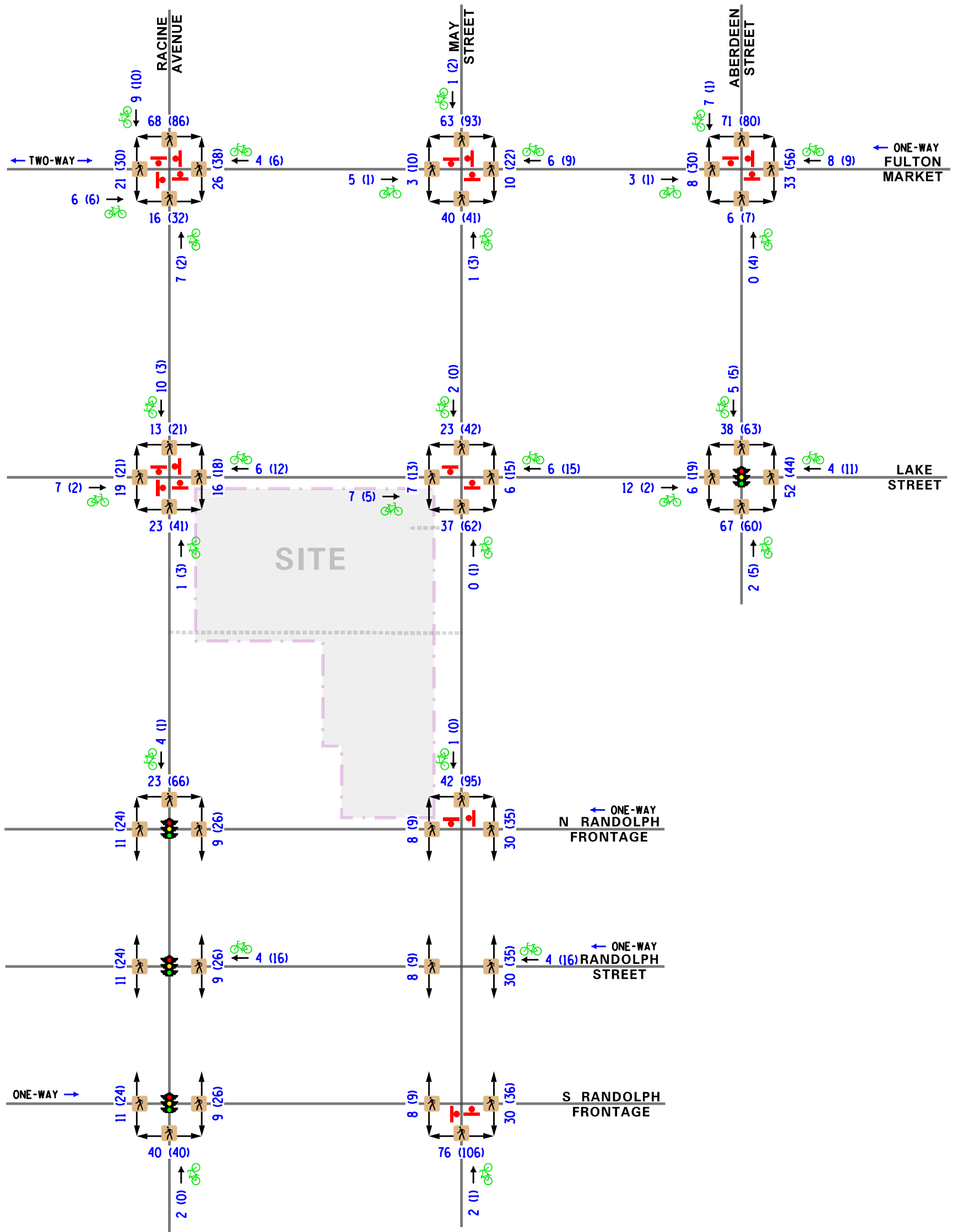

LEGEND

- 00 - AM PEAK HOUR (8:00-9:00 AM)
- (00) - PM PEAK HOUR (5:00-6:00 PM)
- 00 (00) - PEDESTRIAN VOLUME
- 00 (00) - BICYCLE VOLUME

As can be seen from the available census data for the region, approximately 20 percent of residents within the study area currently utilize public transportation to travel to/from work. Furthermore, when taking into consideration walking, bicycling, and those who work from home, approximately 50 to 70 percent of workers utilize other modes of transportation (or do not commute) other than a single occupancy vehicle.

Furthermore, a review of the population trends for Census Tract 8330 indicated that the census tract experienced an approximately 1.57 times growth in population and a 1.90 times growth in employment (population 16 and over) between 2010 and 2022. It is anticipated with the numerous proposed mixed-use developments within the region, that the population and employment characteristics of the area will continue to grow in the future.

The census data and map illustrating the census tracts surrounding the site is included in the Appendix.

Conclusions from Existing Conditions

Given that the site is located within one-quarter mile of the Morgan CTA station, one half mile of the Ashland CTA station and with bus routes provided on Halsted Street, Madison Street and Grand Avenue, the site is well served by public transportation.

A review of the pedestrian counts indicates that all six of the study area intersections experience similar traffic volumes with the majority of pedestrian activity occurring along Lake Street and Fulton Market. Overall, these pedestrian volumes at all six intersections are projected to experience an increase with the development of the numerous proposed mixed-use developments located adjacent to the subject site.

A review of the bicycle data for the study area intersections indicate that bicycle traffic is significant on Lake Street and Fulton Market. This is the result of the provision of separate bike lanes on Lake Street coupled with the one-way westbound vehicular traffic designation and the limited volume of vehicular traffic on Fulton Market.

Overall, within the study area adequate pedestrian facilities are provided under existing conditions and meet CDOT standards or will be incorporated to CDOT standards as part of the subject development or other planned area developments and as such, there is no need for any supplemental facilities to enhance pedestrian connections.

Estimated Development Trips

The number of peak hour trips estimated to be generated by the proposed development were based on trip generation rates published by the Institute of Transportation Engineers (ITE) in *Trip Generation Manual*, 11th Edition. **Table 1** summarizes the multimodal vehicle trip generation during the weekday morning and weekday evening peak hours for the residential units.

Table 1

MULTIMODAL VEHICLE TRIP GENERATION – WEEKDAY PEAK HOUR - RESIDENTIAL

Mode	Weekday Morning Peak Hour	Weekday Evening Peak Hour	Mode Share
Personal Automobile/ Taxi/ Ride Hail Service	53	64	29%
CTA Rapid Transit/Bus	37	44	20%
Bicycle	11	13	6%
Walk	39	46	21%
Work From Home	44	53	24%
Total	184	220	100%

Recommendations

The following provides possible Travel Demand Management (TDM) strategies, an implementation plan, and a monitoring/reporting plan.

Travel Demand Management Strategies

TDM strategies are plans that a development can implement to reduce the number of vehicle trips that would be generated. These strategies are meant to not only reduce the traffic to and from the development but also to reduce parking demand, increase the use of alternate modes of transportation and public transit ridership, and promote active lifestyles less dependent on personal vehicles.

The following TDM strategies will be incorporated as part of the proposed residential development in order to minimize the single occupancy vehicle trips generated by residents.

- *Car-Sharing* is currently provided via two carsharing vehicles. One located 850 feet northwest of the site at 1300 W. Fulton Market and the other located 2,450 feet southeast of the site at 737 W. Washington Boulevard. In order to enhance the presence of car-sharing vehicles for the area, a car-sharing vehicle will be provided in each of the proposed parking garages and information regarding the car sharing services will be provided to residents via building management.
- *Charging for Parking/Unbundling Parking Costs from Unit Leases* is an effective method to reduce traffic to and from the development as well as reduce the demand for on-site parking. Furthermore, with unbundling parking costs from unit leases, tenants may opt to have no vehicle before moving into their unit. Parking will be an unbundled cost from the leases of the residential units.

- *Transit Information* regarding the CTA Blue, Green, and Pink lines as well as local bus routes will be made available for residents. This information will be made available by the building management via an electronic messaging board in each building and tenant mobile application.
- *Real-Time Transit Information* will be made available for residents by management via link to available transit monitoring services to inform potential transit users of approaching trains and buses.
- *Bike Storage and Bike Repair Facilities* provide a secure place to store bicycles, including cargo bikes, out of the elements. In addition, the space and tools to perform minor repairs, when necessary, will further encourage bicycle commuting. These services will be provided to residents, and will be maintained by the residential building management.
- *Bike Sharing* via Divvy is already available in the area via several stations located within the vicinity of the site with the closest station at the intersection of Lake Street and Carpenter Street. Promotion of Divvy bikes and scooters will be made available to residents via the leasing office. Copies of the most recent Chicago Bike Map, published by CDOT, will also be provided.
- *Convertible Parking Deck.* Design the parking deck to allow for the conversion of the top floor for a future different use.

Implementation Plan

The following provides an outline of the steps that will be taken to implement the recommended TDM strategies. The implementation of the TDM strategies will be the responsibility of building management who will inform and educate staff about the TDM strategies. The implementation for the residential TDM strategies will be as follows:

- *Welcoming/Promotional Documents* will be provided to new tenants upon move in. The management company will be responsible for providing this information to new residents and will include information on car-sharing, bike-sharing, and transit as listed in the TDM Strategies.
- *Lease Agreements* will include the lease of parking spaces as an added cost. The implementation of this strategy is the responsibility of the management company which will be required to unbundle parking spaces from apartment leases.
- *Building Amenities* will consist of 1) an electronic information board located in the lobby of each building that will alternate between different information items including real-time transit information and 2) information available in the leasing office or via a tenant mobile application that is made available to all tenants regarding bike-sharing and transit as listed in the TDM Strategies. These will be provided upon occupancy. Maintenance and updates of these amenities will be the responsibility of the building management.

- *Bike Amenities* will include a bike storage area with a ratio of one space per unit. Bike maintenance and repair facilities will be provided within the storage area and the bike storage spaces will be wide enough to accommodate cargo bicycles. Future maintenance of the storage area and other bike facilities is the responsibility of the building management.

Outreach and Engagement

As outlined in the TDM Strategies and Implementation Plan, outreach and engagement will primarily occur through welcoming/promotional documentation, information available in the leasing office, monthly newsletters and emails, and routine communication via the resident application, email or text messaging. This information will be provided to all future residents on an ongoing basis.

Monitoring and Reporting Plan

The development TDM Strategies and Implementation should be monitored in the future to ensure their adequacy. The following summarizes the monitoring and reporting procedures for the residential units.

- *Designated Contacts* for the development will be provided to CDOT and will include a representative from the building management company once selected.
- *Annual Resident Surveys* should be conducted to determine the effectiveness of the TDM Plan. This survey will be managed by the apartment management company and should be submitted to CDOT. This survey should include questions on the following:
 - Unit population/occupancy
 - Vehicle and Bike ownership
 - Transit methods used for both commuting and other purposes
 - Availability of information on transit and TDM Strategies
- *Annual Operational Surveys/Evaluations* should be conducted by building management to determine the effectiveness of the TDM Plan. The results of the surveys/evaluations should be provided to CDOT. The following surveys and evaluations should be conducted.
 - Parking occupancy surveys of dedicated residential spaces
 - Evaluation of the lobby amenities
 - Evaluation of the bike amenities

Estimated Vehicle Trip Reductions

The *TDM Success Stories* report prepared by the Victoria Transport Policy Institute dated March 2024, which is a compilation of studies for existing TDM policies and programs, provides examples of effective transportation demand management strategies that have been implemented in other regions. Based on information provided in the report, it is anticipated that the implementation of the TDM strategies, and the location of the subject development, may result in the following reduction to single occupancy vehicle trips.

- *Car Sharing.* The provision of one car sharing vehicle can replace 12 to 15 private cars.
 - A total of two carsharing vehicles are available within the vicinity of the site and one carshare vehicle will be provided in each of the proposed parking garages.
- *Unbundled Parking.* Unbundled parking from leases will typically reduce vehicle ownership by 5 to 15 percent and vehicle trips by 10 to 30 percent.
 - Parking for the development will be unbundled from leases and will be a separate cost.
- *Providing Transit Information and Real Time Transit Monitors.* Proximity to available high quality public transportation may increase transit travel by 20 to 50 percent and reduce auto travel by 5 to 15 percent.
 - The site is located approximately one-quarter mile from the Morgan CTA Pink/Green Line Station and within one-half mile of the Ashland CTA Pink/Green Line and Grand CTA Blue Line stations and two area bus routes. Information will be provided to residents of the development.
- *Bike Storage and Bike Repair Facilities/Bike Sharing.* The application of Complete Street policies and provision of bike lanes to reduce traffic speeds can increase non-auto travel by 20 to 100 percent and decrease auto travel by 10 to 30 percent.
 - Exclusive bike lanes are currently provided on Lake Street.
 - Four Divvy stations are located within vicinity of the site.
 - In the future, Racine Avenue and May Street will provide separate bicycle lanes.
- In general, micro-modes of transportation (walking, bicycling, e-bikes, etc.) may reduce driving 5 to 15 percent.
 - The study area currently provides sidewalk on both sides of the streets.

Furthermore, mixed-use neighborhoods can reduce annual miles traveled by 20 to 60 percent. The site is located in a growing mixed-use neighborhood providing access to existing commercial, residential, and office land-uses as well as numerous planned mixed-use developments.

Appendix

Traffic Count Summary Sheets
Census Data

Traffic Count Summary Sheets

Aberdeen and Lake TMC - TMC

Tue Mar 26, 2024

Full Length (7 AM-9 AM, 4 PM-8 PM)

All Classes (Lights, Single-Unit Trucks, Articulated Trucks, Buses, Pedestrians, Bicycles on Road)

All Movements

ID: 1165695, Location: 41.88551, -87.654424



Provided by: Kenig Lindgren O'Hara Aboona, Inc.
9575 W. Higgins Rd., Suite 400,
Rosemont, IL, 60018, US

Leg Direction	Aberdeen Street Southbound						Lake Street Westbound						Aberdeen Street Northbound						Lake Street Eastbound						Int
	R	T	L	U	App	Ped*	R	T	L	U	App	Ped*	R	T	L	U	App	Ped*	R	T	L	U	App	Ped*	
2024-03-26																									
7:00AM	3	7	3	0	13	4	5	46	0	0	51	1	2	7	4	0	13	6	2	40	4	0	46	2	123
7:15AM	1	5	3	0	9	8	5	49	3	0	57	6	2	7	2	0	11	12	7	46	1	0	54	0	131
7:30AM	2	8	2	0	12	3	3	45	3	0	51	7	3	9	5	0	17	12	5	65	3	0	73	1	153
7:45AM	3	13	2	0	18	10	3	43	0	0	46	9	5	5	1	0	11	11	2	67	1	0	70	3	145
Hourly Total	9	33	10	0	52	25	16	183	6	0	205	23	12	28	12	0	52	41	16	218	9	0	243	6	552
8:00AM	4	21	3	0	28	5	3	44	1	0	48	9	6	15	2	0	23	10	6	73	2	0	81	2	180
8:15AM	2	18	1	1	22	12	2	44	4	0	50	14	10	11	3	0	24	18	7	72	7	0	86	1	182
8:30AM	1	13	4	0	18	12	2	47	4	0	53	15	7	7	1	0	15	20	5	72	3	0	80	1	166
8:45AM	3	12	4	0	19	9	5	44	3	0	52	14	1	9	3	0	13	19	5	61	3	0	69	2	153
Hourly Total	10	64	12	1	87	38	12	179	12	0	203	52	24	42	9	0	75	67	23	278	15	0	316	6	681
4:00PM	3	12	4	0	19	12	5	90	3	0	98	8	3	13	9	0	25	21	4	56	3	0	63	4	205
4:15PM	4	21	8	0	33	13	2	95	4	0	101	8	2	20	3	0	25	9	6	66	2	0	74	3	233
4:30PM	3	15	9	0	27	13	8	81	1	0	90	6	3	12	3	0	18	9	7	53	3	0	63	4	198
4:45PM	4	13	5	0	22	22	6	106	4	0	116	11	4	23	5	0	32	22	6	62	2	0	70	0	240
Hourly Total	14	61	26	0	101	60	21	372	12	0	405	33	12	68	20	0	100	61	23	237	10	0	270	11	876
5:00PM	5	21	2	0	28	15	6	86	4	0	96	19	7	28	8	0	43	20	4	63	2	0	69	12	236
5:15PM	6	13	4	0	23	16	4	90	7	0	101	16	5	18	5	0	28	27	10	47	2	0	59	6	211
5:30PM	4	12	3	0	19	14	5	87	4	0	96	14	9	17	5	0	31	21	10	48	2	0	60	9	206
5:45PM	3	12	2	0	17	13	4	93	6	0	103	17	8	23	8	0	39	14	7	60	4	0	71	8	230
Hourly Total	18	58	11	0	87	58	19	356	21	0	396	66	29	86	26	0	141	82	31	218	10	0	259	35	883
6:00PM	4	9	6	0	19	11	1	70	5	0	76	8	6	12	4	0	22	13	4	47	3	0	54	2	171
6:15PM	6	15	3	0	24	3	1	57	4	0	62	18	9	10	5	0	24	21	3	55	0	0	58	5	168
6:30PM	0	19	7	0	26	10	2	70	7	0	79	7	2	11	2	0	15	11	7	50	0	0	57	1	177
6:45PM	2	5	2	0	9	7	1	80	4	0	85	6	8	13	1	0	22	15	6	48	2	0	56	1	172
Hourly Total	12	48	18	0	78	31	5	277	20	0	302	39	25	46	12	0	83	60	20	200	5	0	225	9	688
7:00PM	2	14	4	0	20	4	3	71	2	0	76	6	6	7	2	0	15	6	6	52	0	0	58	1	169
7:15PM	0	10	3	0	13	11	0	61	3	0	64	13	6	8	6	0	20	6	1	61	1	0	63	4	160
7:30PM	3	7	2	0	12	4	4	54	7	0	65	4	6	10	4	0	20	4	8	61	2	0	71	0	168
7:45PM	0	6	1	0	7	4	1	34	6	0	41	4	4	9	2	0	15	7	6	41	0	0	47	0	110
Hourly Total	5	37	10	0	52	23	8	220	18	0	246	27	22	34	14	0	70	23	21	215	3	0	239	5	607
Total	68	301	87	1	457	235	81	1587	89	0	1757	240	124	304	93	0	521	334	134	1366	52	0	1552	72	4287
% Approach	14.9%	65.9%	19.0%	0.2%	-	-	4.6%	90.3%	5.1%	0%	-	-	23.8%	58.3%	17.9%	0%	-	-	8.6%	88.0%	3.4%	0%	-	-	-
% Total	1.6%	7.0%	2.0%	0%	10.7%	-	1.9%	37.0%	2.1%	0%	41.0%	-	2.9%	7.1%	2.2%	0%	12.2%	-	3.1%	31.9%	1.2%	0%	36.2%	-	-
Lights	66	277	83	1	427	-	78	1517	83	0	1678	-	120	294	90	0	504	-	130	1295	50	0	1475	-	4084
% Lights	97.1%	92.0%	95.4%	100%	93.4%	-	96.3%	95.6%	93.3%	0%	95.5%	-	96.8%	96.7%	96.8%	0%	96.7%	-	97.0%	94.8%	96.2%	0%	95.0%	-	95.3%
Single-Unit Trucks	0	6	1	0	7	-	1	22	1	0	24	-	0	1	1	0	2	-	2	40	1	0	43	-	76
% Single-Unit Trucks	0%	2.0%	1.1%	0%	1.5%	-	1.2%	1.4%	1.1%	0%	1.4%	-	0%	0.3%	1.1%	0%	0.4%	-	1.5%	2.9%	1.9%	0%	2.8%	-	1.8%
Articulated Trucks	0	0	1	0	1	-	0	1	0	0	1	-	0	0	0	0	0	-	0	2	0	0	2	-	4
% Articulated Trucks	0%	0%	1.1%	0%	0.2%	-	0%	0.1%	0%	0%	0.1%	-	0%	0%	0%	0%	0%	-	0%	0.1%	0%	0%	0.1%	-	0.1%
Buses	0	5	1	0	6	-	0	1	0	0	1	-	1	0	0	0	1	-	0	0	0	0	0	-	8
% Buses	0%	1.7%	1.1%	0%	1.3%	-	0%	0.1%	0%	0%	0.1%	-	0.8%	0%	0%	0%	0.2%	-	0%	0%	0%	0%	0%	-	0.2%
Bicycles on Road	2	13	1	0	16	-	2	46	5	0	53	-	3	9	2	0	14	-	2	29	1	0	32	-	115
% Bicycles on Road	2.9%	4.3%	1.1%	0%	3.5%	-	2.5%	2.9%	5.6%	0%	3.0%	-	2.4%	3.0%	2.2%	0%	2.7%	-	1.5%	2.1%	1.9%	0%	2.1%	-	2.7%
Pedestrians	-	-	-	-	-	235	-	-	-	-	240	-	-	-	-	-	334	-	-	-	-	-	72	-	
% Pedestrians	-	-	-	-	-	100%	-	-	-	-	100%	-	-	-	-	-	100%	-	-	-	-	-	100%	-	

*Pedestrians and Bicycles on Crosswalk. L: Left, R: Right, T: Thru, U: U-Turn

Aberdeen and Lake TMC - TMC

Tue Mar 26, 2024

Full Length (7 AM-9 AM, 4 PM-8 PM)

All Classes (Lights, Single-Unit Trucks, Articulated Trucks, Buses, Pedestrians, Bicycles on Road)

All Movements

ID: 1165695, Location: 41.88551, -87.654424



Provided by: Kenig Lindgren O'Hara Aboona, Inc.

9575 W. Higgins Rd., Suite 400,
Rosemont, IL, 60018, US

[N] Aberdeen Street

Total: 895

In: 457 Out: 438

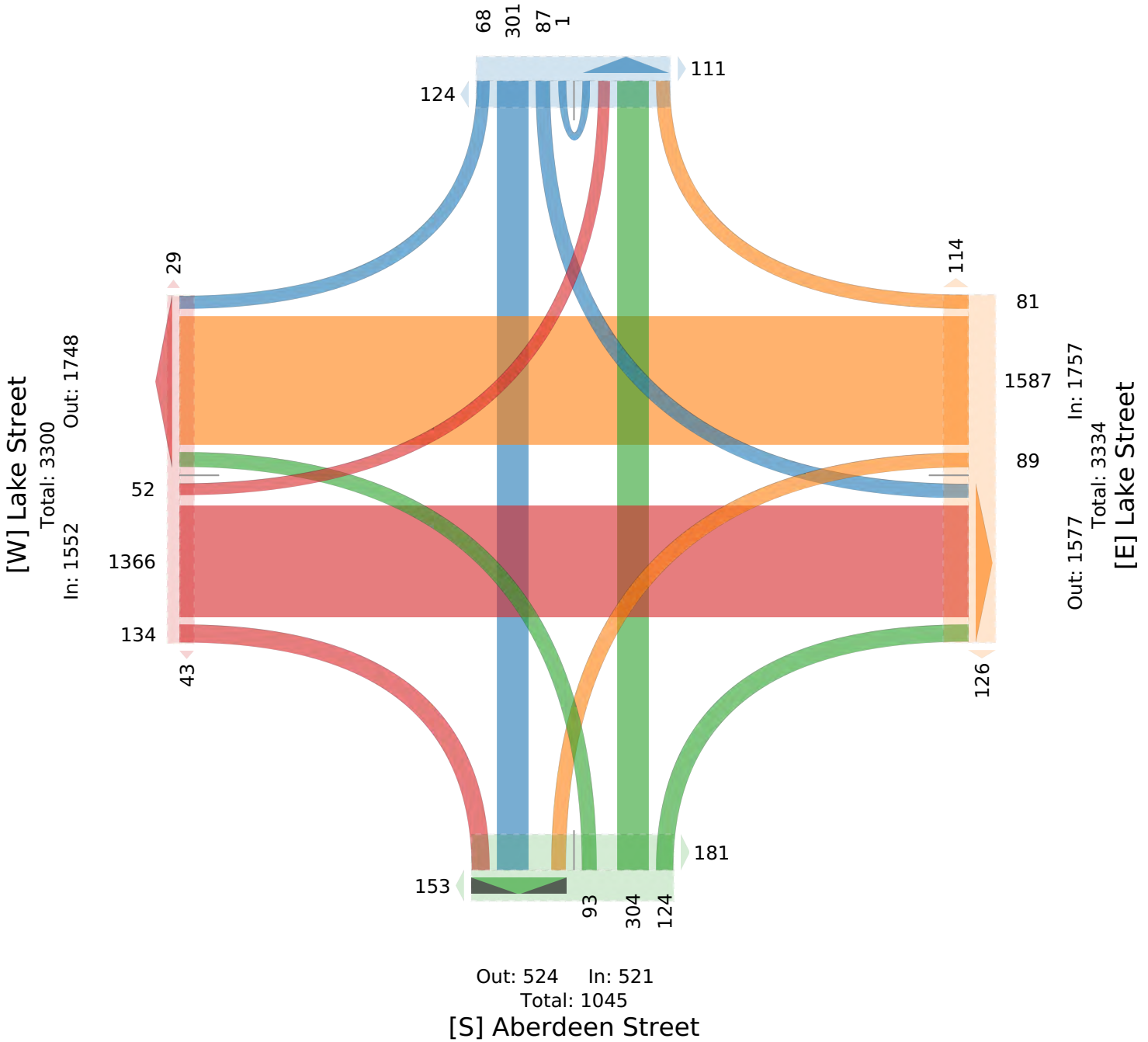

Aberdeen and Lake TMC - TMC

Tue Mar 26, 2024

AM Peak (8 AM - 9 AM)

All Classes (Lights, Single-Unit Trucks, Articulated Trucks, Buses, Pedestrians, Bicycles on Road)

All Movements

ID: 1165695, Location: 41.88551, -87.654424



Provided by: Kenig Lindgren O'Hara Aboona, Inc.
9575 W. Higgins Rd., Suite 400,
Rosemont, IL, 60018, US

Leg Direction	Aberdeen Street Southbound							Lake Street Westbound							Aberdeen Street Northbound							Lake Street Eastbound							Int
	R	T	L	U	App	Ped*		R	T	L	U	App	Ped*		R	T	L	U	App	Ped*		R	T	L	U	App	Ped*		
2024-03-26 8:00AM	4	21	3	0	28	5		3	44	1	0	48	9		6	15	2	0	23	10		6	73	2	0	81	2		180
8:15AM	2	18	1	1	22	12		2	44	4	0	50	14		10	11	3	0	24	18		7	72	7	0	86	1		182
8:30AM	1	13	4	0	18	12		2	47	4	0	53	15		7	7	1	0	15	20		5	72	3	0	80	1		166
8:45AM	3	12	4	0	19	9		5	44	3	0	52	14		1	9	3	0	13	19		5	61	3	0	69	2		153
Total	10	64	12	1	87	38		12	179	12	0	203	52		24	42	9	0	75	67		23	278	15	0	316	6		681
% Approach	11.5%	73.6%	13.8%	1.1%	-	-		5.9%	88.2%	5.9%	0%	-	-	32.0%	56.0%	12.0%	0%	-	-	7.3%	88.0%	4.7%	0%	-	-	-	-		
% Total	1.5%	9.4%	1.8%	0.1%	12.8%	-		1.8%	26.3%	1.8%	0%	29.8%	-	3.5%	6.2%	1.3%	0%	11.0%	-	3.4%	40.8%	2.2%	0%	46.4%	-	-	-		
PHF	0.625	0.750	0.688	0.250	0.759	-		0.600	0.951	0.750	-	0.957	-	0.600	0.667	0.750	-	0.760	-	0.875	0.944	0.536	-	0.916	-	0.935	-		
Lights	10	56	9	1	76	-		12	167	12	0	191	-	24	40	9	0	73	-	21	253	15	0	289	-	629	-		
% Lights	100%	87.5%	75.0%	100%	87.4%	-		100%	93.3%	100%	0%	94.1%	-	100%	95.2%	100%	0%	97.3%	-	91.3%	91.0%	100%	0%	91.5%	-	92.4%	-		
Single-Unit Trucks	0	2	1	0	3	-		0	8	0	0	8	-	0	0	0	0	0	-	0	14	0	0	14	-	25	-		
% Single-Unit Trucks	0%	3.1%	8.3%	0%	3.4%	-		0%	4.5%	0%	0%	3.9%	-	0%	0%	0%	0%	0%	-	0%	5.0%	0%	0%	4.4%	-	3.7%	-		
Articulated Trucks	0	0	1	0	1	-		0	0	0	0	0	-	0	0	0	0	0	-	0	1	0	0	1	-	2	-		
% Articulated Trucks	0%	0%	8.3%	0%	1.1%	-		0%	0%	0%	0%	0%	-	0%	0%	0%	0%	0%	-	0%	0.4%	0%	0%	0.3%	-	0.3%	-		
Buses	0	2	0	0	2	-		0	0	0	0	0	-	0	0	0	0	0	-	0	0	0	0	0	-	2	-		
% Buses	0%	3.1%	0%	0%	2.3%	-		0%	0%	0%	0%	0%	-	0%	0%	0%	0%	0%	-	0%	0%	0%	0%	0%	-	0.3%	-		
Bicycles on Road	0	4	1	0	5	-		0	4	0	0	4	-	0	2	0	0	2	-	2	10	0	0	12	-	23	-		
% Bicycles on Road	0%	6.3%	8.3%	0%	5.7%	-		0%	2.2%	0%	0%	2.0%	-	0%	4.8%	0%	0%	2.7%	-	8.7%	3.6%	0%	0%	3.8%	-	3.4%	-		
Pedestrians	-	-	-	-	-	38		-	-	-	-	-	52		-	-	-	-	-	67		-	-	-	-	-	6		-
% Pedestrians	-	-	-	-	-	100%		-	-	-	-	-	100%		-	-	-	-	-	100%		-	-	-	-	-	-	100%	-

*Pedestrians and Bicycles on Crosswalk. L: Left, R: Right, T: Thru, U: U-Turn

Aberdeen and Lake TMC - TMC

Tue Mar 26, 2024

AM Peak (8 AM - 9 AM)

All Classes (Lights, Single-Unit Trucks, Articulated Trucks, Buses, Pedestrians, Bicycles on Road)

All Movements

ID: 1165695, Location: 41.88551, -87.654424



Provided by: Kenig Lindgren O'Hara Aboona, Inc.

9575 W. Higgins Rd., Suite 400,
Rosemont, IL, 60018, US

[N] Aberdeen Street

Total: 157

In: 87 Out: 70

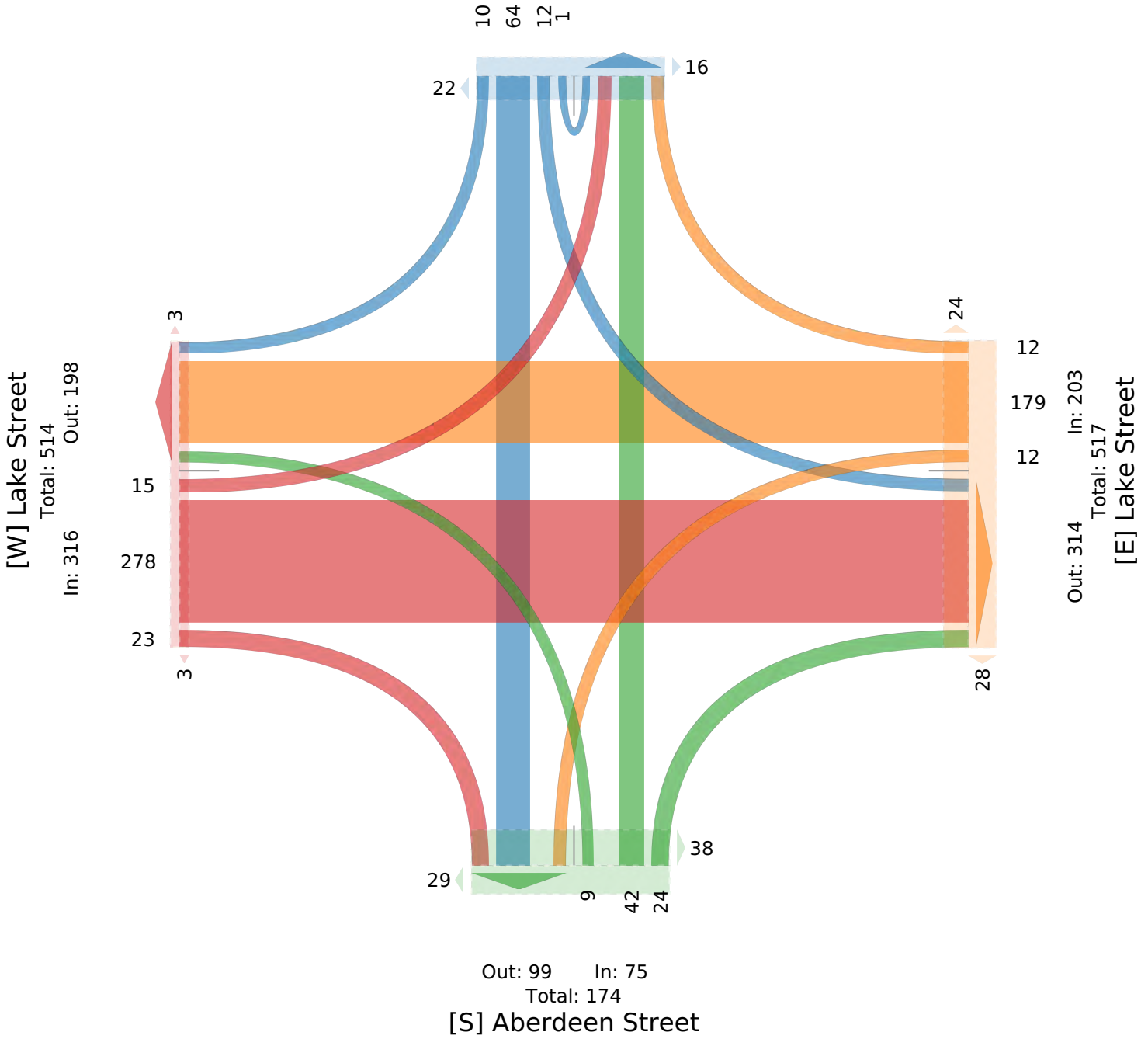

Aberdeen and Lake TMC - TMC

Tue Mar 26, 2024

PM Peak (4:15 PM - 5:15 PM) - Overall Peak Hour

All Classes (Lights, Single-Unit Trucks, Articulated Trucks, Buses, Pedestrians, Bicycles on Road)

All Movements

ID: 1165695, Location: 41.88551, -87.654424



Provided by: Kenig Lindgren O'Hara Aboona, Inc.

9575 W. Higgins Rd., Suite 400,
Rosemont, IL, 60018, US

Leg Direction	Aberdeen Street Southbound						Lake Street Westbound						Aberdeen Street Northbound						Lake Street Eastbound						Int
	R	T	L	U	App	Ped*	R	T	L	U	App	Ped*	R	T	L	U	App	Ped*	R	T	L	U	App	Ped*	
2024-03-26																									
4:15PM	4	21	8	0	33	13	2	95	4	0	101	8	2	20	3	0	25	9	6	66	2	0	74	3	233
4:30PM	3	15	9	0	27	13	8	81	1	0	90	6	3	12	3	0	18	9	7	53	3	0	63	4	198
4:45PM	4	13	5	0	22	22	6	106	4	0	116	11	4	23	5	0	32	22	6	62	2	0	70	0	240
5:00PM	5	21	2	0	28	15	6	86	4	0	96	19	7	28	8	0	43	20	4	63	2	0	69	12	236
Total	16	70	24	0	110	63	22	368	13	0	403	44	16	83	19	0	118	60	23	244	9	0	276	19	907
% Approach	14.5%	63.6%	21.8%	0%	-	-	5.5%	91.3%	3.2%	0%	-	-	13.6%	70.3%	16.1%	0%	-	-	8.3%	88.4%	3.3%	0%	-	-	-
% Total	1.8%	7.7%	2.6%	0%	12.1%	-	2.4%	40.6%	1.4%	0%	44.4%	-	1.8%	9.2%	2.1%	0%	13.0%	-	2.5%	26.9%	1.0%	0%	30.4%	-	-
PHF	0.750	0.825	0.667	-	0.820	-	0.688	0.875	0.813	-	0.875	-	0.571	0.741	0.531	-	0.673	-	0.821	0.917	0.750	-	0.926	-	0.957
Lights	15	65	24	0	104	-	22	354	12	0	388	-	16	80	17	0	113	-	23	239	9	0	271	-	876
% Lights	93.8%	92.9%	100%	0%	94.5%	-	100%	96.2%	92.3%	0%	96.3%	-	100%	96.4%	89.5%	0%	95.8%	-	100%	98.0%	100%	0%	98.2%	-	96.6%
Single-Unit Trucks	0	0	0	0	0	-	0	2	1	0	3	-	0	0	0	0	0	-	0	3	0	0	3	-	6
% Single-Unit Trucks	0%	0%	0%	0%	0%	-	0%	0.5%	7.7%	0%	0.7%	-	0%	0%	0%	0%	0%	-	0%	1.2%	0%	0%	1.1%	-	0.7%
Articulated Trucks	0	0	0	0	0	-	0	0	0	0	0	-	0	0	0	0	0	-	0	0	0	0	0	-	0
% Articulated Trucks	0%	0%	0%	0%	0%	-	0%	0%	0%	0%	0%	-	0%	0%	0%	0%	0%	-	0%	0%	0%	0%	0%	-	0%
Buses	0	1	0	0	1	-	0	1	0	0	1	-	0	0	0	0	0	-	0	0	0	0	0	-	2
% Buses	0%	1.4%	0%	0%	0.9%	-	0%	0.3%	0%	0%	0.2%	-	0%	0%	0%	0%	0%	-	0%	0%	0%	0%	0%	-	0.2%
Bicycles on Road	1	4	0	0	5	-	0	11	0	0	11	-	0	3	2	0	5	-	0	2	0	0	2	-	23
% Bicycles on Road	6.3%	5.7%	0%	0%	4.5%	-	0%	3.0%	0%	0%	2.7%	-	0%	3.6%	10.5%	0%	4.2%	-	0%	0.8%	0%	0%	0.7%	-	2.5%
Pedestrians	-	-	-	-	-	63	-	-	-	-	-	44	-	-	-	-	-	60	-	-	-	-	-	19	-
% Pedestrians	-	-	-	-	-	100%	-	-	-	-	-	100%	-	-	-	-	-	100%	-	-	-	-	-	100%	-

*Pedestrians and Bicycles on Crosswalk. L: Left, R: Right, T: Thru, U: U-Turn

Aberdeen and Lake TMC - TMC

Tue Mar 26, 2024

PM Peak (4:15 PM - 5:15 PM) - Overall Peak Hour

All Classes (Lights, Single-Unit Trucks, Articulated Trucks, Buses, Pedestrians, Bicycles on Road)

All Movements

ID: 1165695, Location: 41.88551, -87.654424



Provided by: Kenig Lindgren O'Hara Aboona, Inc.

9575 W. Higgins Rd., Suite 400,
Rosemont, IL, 60018, US

[N] Aberdeen Street

Total: 224

In: 110 Out: 114

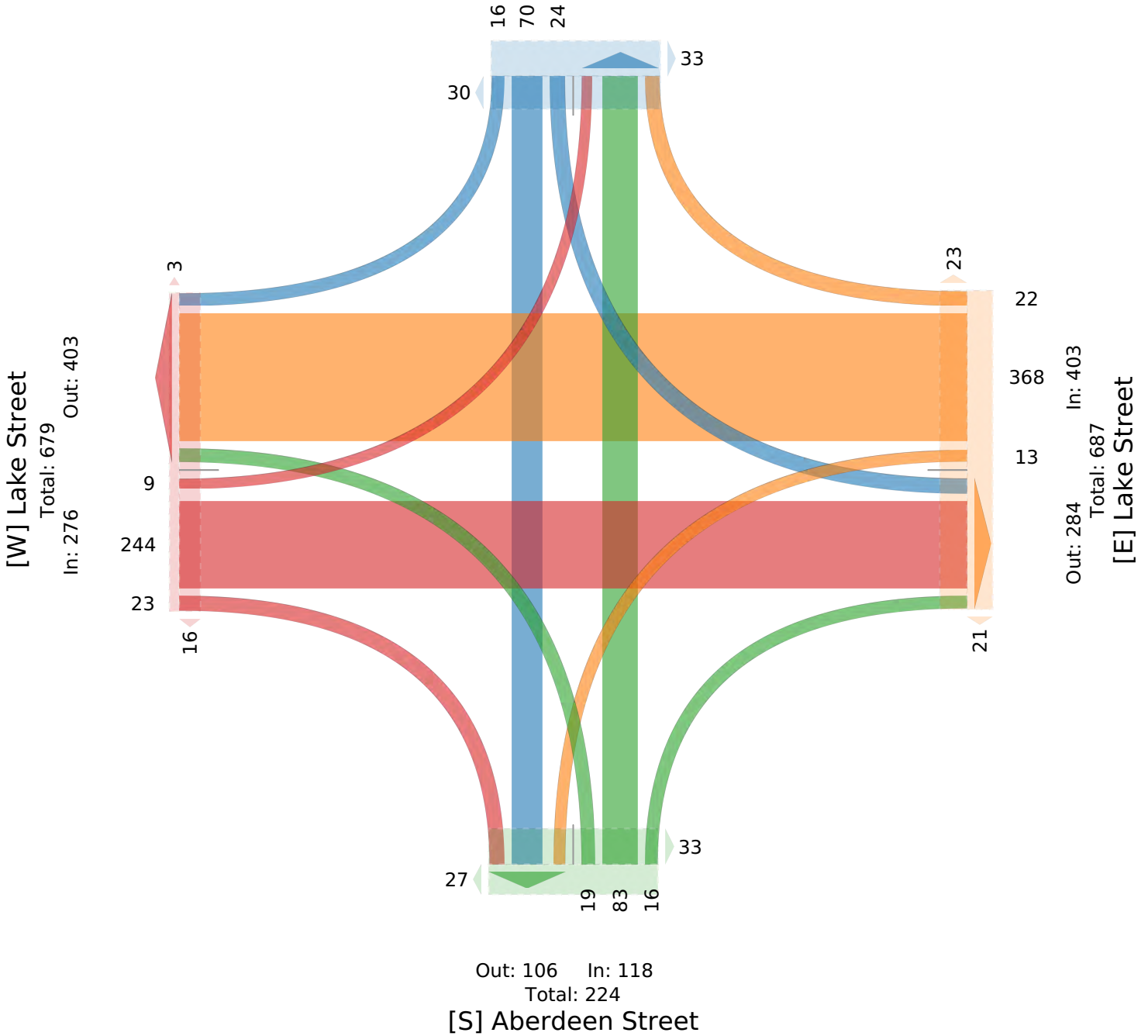

Lake and Racine TMC - TMC

Tue Mar 26, 2024

Full Length (7 AM-9 AM, 4 PM-8 PM)

All Classes (Lights, Single-Unit Trucks, Articulated Trucks, Buses, Pedestrians, Bicycles on Road)

All Movements

ID: 1165692, Location: 41.885509, -87.656826



Provided by: Kenig Lindgren O'Hara Aboona, Inc.
9575 W. Higgins Rd., Suite 400,
Rosemont, IL, 60018, US

Leg Direction	Racine Avenue Southbound						Lake Street Westbound						Racine Avenue Northbound						Lake Street Eastbound						Int
	R	T	L	U	App	Ped*	R	T	L	U	App	Ped*	R	T	L	U	App	Ped*	R	T	L	U	App	Ped*	
2024-03-26																									
7:00AM	4	14	10	0	28	2	0	47	2	0	49	4	5	7	3	0	15	0	2	41	3	0	46	2	138
7:15AM	2	18	8	0	28	0	1	44	2	0	47	0	2	9	2	0	13	4	5	53	2	0	60	1	148
7:30AM	8	24	13	0	45	1	2	48	1	1	52	3	5	10	4	0	19	5	6	58	2	0	66	2	182
7:45AM	4	27	12	0	43	2	1	37	5	1	44	5	0	14	2	0	16	2	7	67	2	0	76	0	179
Hourly Total	18	83	43	0	144	5	4	176	10	2	192	12	12	40	11	0	63	11	20	219	9	0	248	5	647
8:00AM	5	18	12	0	35	0	3	41	3	0	47	5	3	17	6	0	26	6	4	79	5	0	88	2	196
8:15AM	8	28	9	0	45	5	2	51	4	0	57	3	6	18	3	0	27	2	7	80	2	0	89	6	218
8:30AM	3	34	14	0	51	2	2	45	1	0	48	6	4	11	8	0	23	10	6	69	8	0	83	3	205
8:45AM	3	31	12	0	46	6	5	42	0	0	47	2	3	12	5	0	20	5	5	76	1	0	82	8	195
Hourly Total	19	111	47	0	177	13	12	179	8	0	199	16	16	58	22	0	96	23	22	304	16	0	342	19	814
4:00PM	6	33	11	0	50	7	6	79	4	0	89	5	7	27	5	0	39	11	2	54	5	0	61	7	239
4:15PM	9	26	14	0	49	3	6	89	6	0	101	2	6	22	6	0	34	8	5	66	5	0	76	3	260
4:30PM	1	30	10	0	41	6	2	83	3	0	88	8	3	22	5	0	30	6	8	56	4	0	68	4	227
4:45PM	8	26	13	0	47	5	2	98	4	0	104	3	6	28	7	0	41	16	2	60	2	0	64	7	256
Hourly Total	24	115	48	0	187	21	16	349	17	0	382	18	22	99	23	0	144	41	17	236	16	0	269	21	982
5:00PM	13	26	14	0	53	4	5	93	7	0	105	8	2	16	3	0	21	12	5	47	3	0	55	2	234
5:15PM	4	36	14	0	54	5	2	88	6	0	96	5	4	23	6	0	33	16	6	45	2	0	53	13	236
5:30PM	6	30	10	0	46	5	5	96	2	0	103	6	5	30	7	0	42	8	7	48	4	0	59	3	250
5:45PM	9	24	13	0	46	8	6	86	4	0	96	5	8	31	1	0	40	3	4	51	4	0	59	13	241
Hourly Total	32	116	51	0	199	22	18	363	19	0	400	24	19	100	17	0	136	39	22	191	13	0	226	31	961
6:00PM	7	34	15	0	56	9	3	70	5	0	78	1	3	15	5	0	23	2	6	43	2	0	51	7	208
6:15PM	8	18	6	0	32	6	3	63	4	0	70	5	8	28	6	0	42	10	4	60	0	0	64	1	208
6:30PM	7	24	5	0	36	4	3	68	4	0	75	6	7	27	4	0	38	6	4	48	0	1	53	5	202
6:45PM	6	22	8	0	36	3	4	81	2	0	87	1	4	24	3	0	31	2	13	52	1	0	66	2	220
Hourly Total	28	98	34	0	160	22	13	282	15	0	310	13	22	94	18	0	134	20	27	203	3	1	234	15	838
7:00PM	2	24	8	0	34	6	3	75	4	0	82	2	5	18	3	0	26	3	10	50	5	0	65	8	207
7:15PM	4	26	5	0	35	1	1	52	1	0	54	4	7	16	3	0	26	3	8	62	2	0	72	4	187
7:30PM	4	16	7	0	27	0	0	56	3	0	59	3	5	9	3	0	17	0	5	52	1	1	59	3	162
7:45PM	5	15	4	0	24	8	2	25	1	0	28	0	6	7	7	0	20	2	12	31	2	0	45	2	117
Hourly Total	15	81	24	0	120	15	6	208	9	0	223	9	23	50	16	0	89	8	35	195	10	1	241	17	673
Total	136	604	247	0	987	98	69	1557	78	2	1706	92	114	441	107	0	662	142	143	1348	67	2	1560	108	4915
% Approach	13.8%	61.2%	25.0%	0%	-	-	4.0%	91.3%	4.6%	0.1%	-	-	17.2%	66.6%	16.2%	0%	-	-	9.2%	86.4%	4.3%	0.1%	-	-	-
% Total	2.8%	12.3%	5.0%	0%	20.1%	-	1.4%	31.7%	1.6%	0%	34.7%	-	2.3%	9.0%	2.2%	0%	13.5%	-	2.9%	27.4%	1.4%	0%	31.7%	-	-
Lights	128	563	237	0	928	-	66	1483	75	2	1626	-	110	427	102	0	639	-	141	1283	63	2	1489	-	4682
% Lights	94.1%	93.2%	96.0%	0%	94.0%	-	95.7%	95.2%	96.2%	100%	95.3%	-	96.5%	96.8%	95.3%	0%	96.5%	-	98.6%	95.2%	94.0%	100%	95.4%	-	95.3%
Single-Unit Trucks	2	3	3	0	8	-	0	20	1	0	21	-	2	2	3	0	7	-	1	42	1	0	44	-	80
% Single-Unit Trucks	1.5%	0.5%	1.2%	0%	0.8%	-	0%	1.3%	1.3%	0%	1.2%	-	1.8%	0.5%	2.8%	0%	1.1%	-	0.7%	3.1%	1.5%	0%	2.8%	-	1.6%
Articulated Trucks	0	0	0	0	0	-	0	1	0	0	1	-	0	1	0	0	1	-	0	1	0	0	1	-	3
% Articulated Trucks	0%	0%	0%	0%	0%	-	0%	0.1%	0%	0%	0.1%	-	0%	0.2%	0%	0%	0.2%	-	0%	0.1%	0%	0%	0.1%	-	0.1%
Buses	4	19	0	0	23	-	0	6	0	0	6	-	0	0	0	0	0	-	0	1	0	0	1	-	30
% Buses	2.9%	3.1%	0%	0%	2.3%	-	0%	0.4%	0%	0%	0.4%	-	0%	0%	0%	0%	0%	-	0%	0.1%	0%	0%	0.1%	-	0.6%
Bicycles on Road	2	19	7	0	28	-	3	47	2	0	52	-	2	11	2	0	15	-	1	21	3	0	25	-	120
% Bicycles on Road	1.5%	3.1%	2.8%	0%	2.8%	-	4.3%	3.0%	2.6%	0%	3.0%	-	1.8%	2.5%	1.9%	0%	2.3%	-	0.7%	1.6%	4.5%	0%	1.6%	-	2.4%
Pedestrians	-	-	-	-	-	98	-	-	-	-	-	92	-	-	-	-	-	142	-	-	-	-	-	108	-
% Pedestrians	-	-	-	-	-	100%	-	-	-	-	-	100%	-	-	-	-	-	100%	-	-	-	-	-	100%	-

*Pedestrians and Bicycles on Crosswalk. L: Left, R: Right, T: Thru, U: U-Turn

Lake and Racine TMC - TMC

Tue Mar 26, 2024

Full Length (7 AM-9 AM, 4 PM-8 PM)

All Classes (Lights, Single-Unit Trucks, Articulated Trucks, Buses, Pedestrians, Bicycles on Road)

All Movements

ID: 1165692, Location: 41.885509, -87.656826



Provided by: Kenig Lindgren O'Hara Aboona, Inc.

9575 W. Higgins Rd., Suite 400,
Rosemont, IL, 60018, US

[N] Racine Avenue

Total: 1564

In: 987 Out: 577

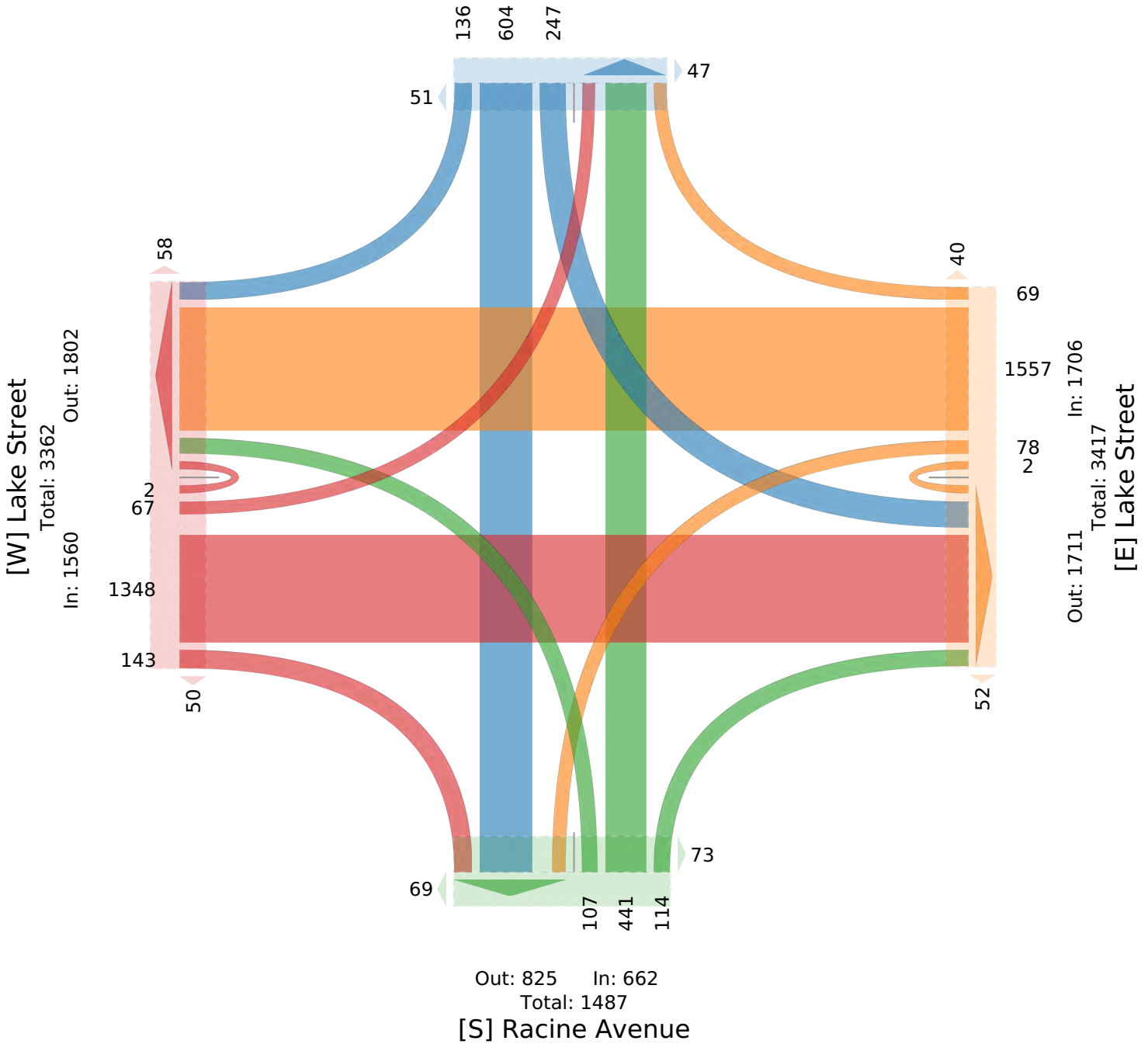

Lake and Racine TMC - TMC

Tue Mar 26, 2024

AM Peak (8 AM - 9 AM)

All Classes (Lights, Single-Unit Trucks, Articulated Trucks, Buses, Pedestrians, Bicycles on Road)

All Movements

ID: 1165692, Location: 41.885509, -87.656826



Provided by: Kenig Lindgren O'Hara Aboona, Inc.
9575 W. Higgins Rd., Suite 400,
Rosemont, IL, 60018, US

Leg Direction	Racine Avenue Southbound						Lake Street Westbound						Racine Avenue Northbound						Lake Street Eastbound						Int
	R	T	L	U	App	Ped*	R	T	L	U	App	Ped*	R	T	L	U	App	Ped*	R	T	L	U	App	Ped*	
2024-03-26																									
8:00AM	5	18	12	0	35	0	3	41	3	0	47	5	3	17	6	0	26	6	4	79	5	0	88	2	196
8:15AM	8	28	9	0	45	5	2	51	4	0	57	3	6	18	3	0	27	2	7	80	2	0	89	6	218
8:30AM	3	34	14	0	51	2	2	45	1	0	48	6	4	11	8	0	23	10	6	69	8	0	83	3	205
8:45AM	3	31	12	0	46	6	5	42	0	0	47	2	3	12	5	0	20	5	5	76	1	0	82	8	195
Total	19	111	47	0	177	13	12	179	8	0	199	16	16	58	22	0	96	23	22	304	16	0	342	19	814
% Approach	10.7%	62.7%	26.6%	0%	-	-	6.0%	89.9%	4.0%	0%	-	-	16.7%	60.4%	22.9%	0%	-	-	6.4%	88.9%	4.7%	0%	-	-	-
% Total	2.3%	13.6%	5.8%	0%	21.7%	-	1.5%	22.0%	1.0%	0%	24.4%	-	2.0%	7.1%	2.7%	0%	11.8%	-	2.7%	37.3%	2.0%	0%	42.0%	-	-
PHF	0.594	0.867	0.786	-	0.888	-	0.550	0.888	0.500	-	0.894	-	0.667	0.838	0.688	-	0.913	-	0.750	0.955	0.500	-	0.963	-	0.940
Lights	19	100	43	0	162	-	11	166	8	0	185	-	16	57	20	0	93	-	21	285	15	0	321	-	761
% Lights	100%	90.1%	91.5%	0%	91.5%	-	91.7%	92.7%	100%	0%	93.0%	-	100%	98.3%	90.9%	0%	96.9%	-	95.5%	93.8%	93.8%	0%	93.9%	-	93.5%
Single-Unit Trucks	0	2	1	0	3	-	0	8	0	0	8	-	0	0	2	0	2	-	0	13	1	0	14	-	27
% Single-Unit Trucks	0%	1.8%	2.1%	0%	1.7%	-	0%	4.5%	0%	0%	4.0%	-	0%	0%	9.1%	0%	2.1%	-	0%	4.3%	6.3%	0%	4.1%	-	3.3%
Articulated Trucks	0	0	0	0	0	-	0	0	0	0	0	-	0	0	0	0	0	-	0	0	0	0	0	-	0
% Articulated Trucks	0%	0%	0%	0%	0%	-	0%	0%	0%	0%	0%	-	0%	0%	0%	0%	0%	-	0%	0%	0%	0%	0%	-	0%
Buses	0	2	0	0	2	-	0	0	0	0	0	-	0	0	0	0	0	-	0	0	0	0	0	-	2
% Buses	0%	1.8%	0%	0%	1.1%	-	0%	0%	0%	0%	0%	-	0%	0%	0%	0%	0%	-	0%	0%	0%	0%	0%	-	0.2%
Bicycles on Road	0	7	3	0	10	-	1	5	0	0	6	-	0	1	0	0	1	-	1	6	0	0	7	-	24
% Bicycles on Road	0%	6.3%	6.4%	0%	5.6%	-	8.3%	2.8%	0%	0%	3.0%	-	0%	1.7%	0%	0%	1.0%	-	4.5%	2.0%	0%	0%	2.0%	-	2.9%
Pedestrians	-	-	-	-	-	13	-	-	-	-	-	16	-	-	-	-	-	23	-	-	-	-	-	19	-
% Pedestrians	-	-	-	-	-	100%	-	-	-	-	-	100%	-	-	-	-	-	100%	-	-	-	-	-	100%	-

* Pedestrians and Bicycles on Crosswalk. L: Left, R: Right, T: Thru, U: U-Turn

Lake and Racine TMC - TMC

Tue Mar 26, 2024

AM Peak (8 AM - 9 AM)

All Classes (Lights, Single-Unit Trucks, Articulated Trucks, Buses, Pedestrians, Bicycles on Road)

All Movements

ID: 1165692, Location: 41.885509, -87.656826



Provided by: Kenig Lindgren O'Hara Aboona, Inc.

9575 W. Higgins Rd., Suite 400,
Rosemont, IL, 60018, US

[N] Racine Avenue

Total: 263

In: 177 Out: 86

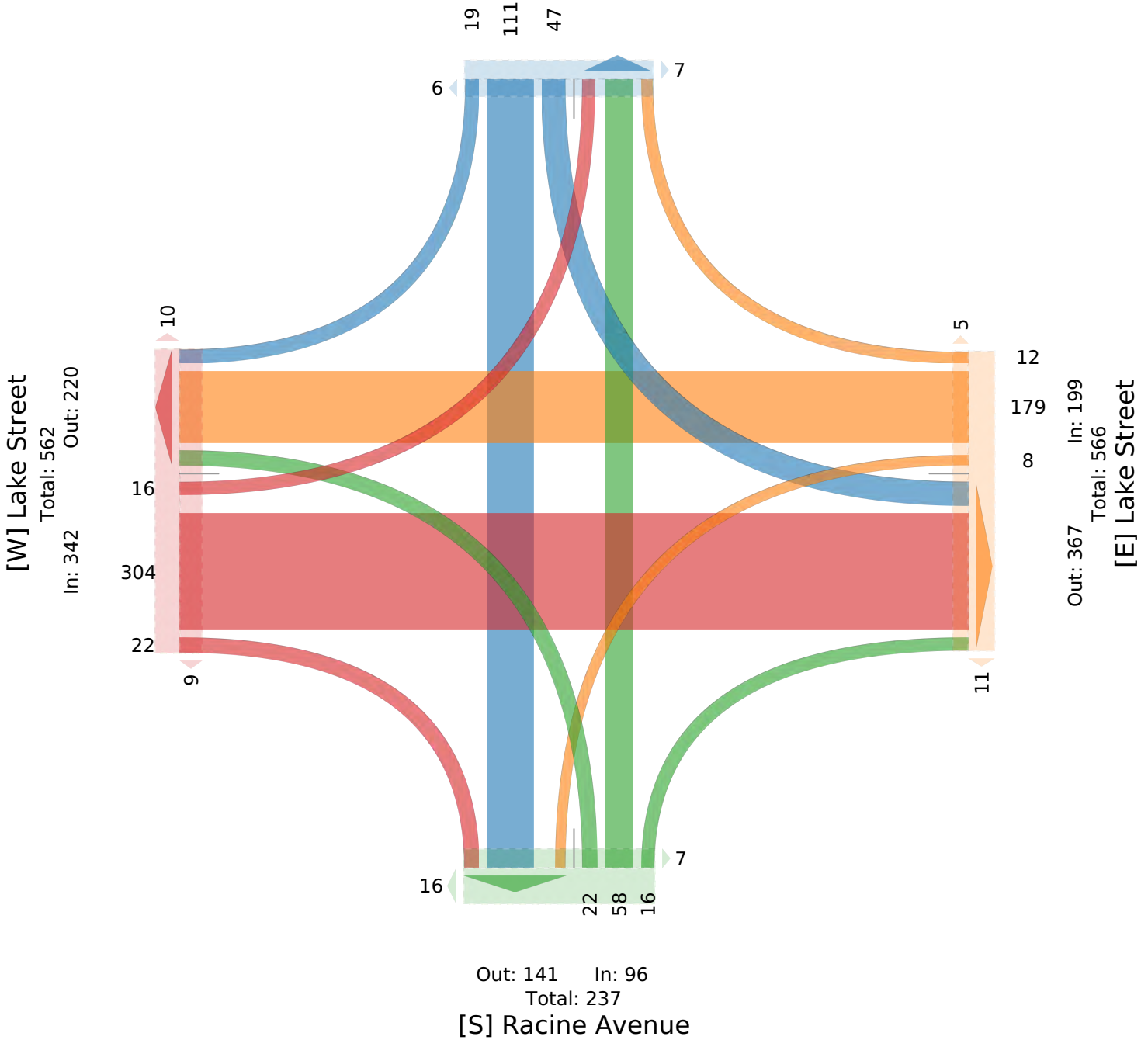

Lake and Racine TMC - TMC

Tue Mar 26, 2024

PM Peak (4 PM - 5 PM) - Overall Peak Hour

All Classes (Lights, Single-Unit Trucks, Articulated Trucks, Buses, Pedestrians, Bicycles on Road)

All Movements

ID: 1165692, Location: 41.885509, -87.656826



Provided by: Kenig Lindgren O'Hara Aboona, Inc.

9575 W. Higgins Rd., Suite 400, Rosemont, IL, 60018, US

Leg Direction	Racine Avenue Southbound						Lake Street Westbound						Racine Avenue Northbound						Lake Street Eastbound						Int
	R	T	L	U	App	Ped*	R	T	L	U	App	Ped*	R	T	L	U	App	Ped*	R	T	L	U	App	Ped*	
2024-03-26																									
4:00PM	6	33	11	0	50	7	6	79	4	0	89	5	7	27	5	0	39	11	2	54	5	0	61	7	239
4:15PM	9	26	14	0	49	3	6	89	6	0	101	2	6	22	6	0	34	8	5	66	5	0	76	3	260
4:30PM	1	30	10	0	41	6	2	83	3	0	88	8	3	22	5	0	30	6	8	56	4	0	68	4	227
4:45PM	8	26	13	0	47	5	2	98	4	0	104	3	6	28	7	0	41	16	2	60	2	0	64	7	256
Total	24	115	48	0	187	21	16	349	17	0	382	18	22	99	23	0	144	41	17	236	16	0	269	21	982
% Approach	12.8%	61.5%	25.7%	0%	-	-	4.2%	91.4%	4.5%	0%	-	-	15.3%	68.8%	16.0%	0%	-	-	6.3%	87.7%	5.9%	0%	-	-	-
% Total	2.4%	11.7%	4.9%	0%	19.0%	-	1.6%	35.5%	1.7%	0%	38.9%	-	2.2%	10.1%	2.3%	0%	14.7%	-	1.7%	24.0%	1.6%	0%	27.4%	-	-
PHF	0.639	0.856	0.857	-	0.939	-	0.667	0.906	0.708	-	0.934	-	0.786	0.898	0.786	-	0.881	-	0.531	0.900	0.800	-	0.890	-	0.939
Lights	21	107	48	0	176	-	16	331	17	0	364	-	22	97	22	0	141	-	17	229	16	0	262	-	943
% Lights	87.5%	93.0%	100%	0%	94.1%	-	100%	94.8%	100%	0%	95.3%	-	100%	98.0%	95.7%	0%	97.9%	-	100%	97.0%	100%	0%	97.4%	-	96.0%
Single-Unit Trucks	0	0	0	0	0	-	0	4	0	0	4	-	0	0	0	0	0	-	0	4	0	0	4	-	8
% Single-Unit Trucks	0%	0%	0%	0%	0%	-	0%	1.1%	0%	0%	1.0%	-	0%	0%	0%	0%	0%	-	0%	1.7%	0%	0%	1.5%	-	0.8%
Articulated Trucks	0	0	0	0	0	-	0	0	0	0	0	-	0	0	0	0	0	-	0	0	0	0	0	-	0
% Articulated Trucks	0%	0%	0%	0%	0%	-	0%	0%	0%	0%	0%	-	0%	0%	0%	0%	0%	-	0%	0%	0%	0%	0%	-	0%
Buses	2	6	0	0	8	-	0	2	0	0	2	-	0	0	0	0	0	-	0	1	0	0	1	-	11
% Buses	8.3%	5.2%	0%	0%	4.3%	-	0%	0.6%	0%	0%	0.5%	-	0%	0%	0%	0%	0%	-	0%	0.4%	0%	0%	0.4%	-	1.1%
Bicycles on Road	1	2	0	0	3	-	0	12	0	0	12	-	0	2	1	0	3	-	0	2	0	0	2	-	20
% Bicycles on Road	4.2%	1.7%	0%	0%	1.6%	-	0%	3.4%	0%	0%	3.1%	-	0%	2.0%	4.3%	0%	2.1%	-	0%	0.8%	0%	0%	0.7%	-	2.0%
Pedestrians	-	-	-	-	-	21	-	-	-	-	-	18	-	-	-	-	-	41	-	-	-	-	-	21	-
% Pedestrians	-	-	-	-	-	100%	-	-	-	-	-	100%	-	-	-	-	-	100%	-	-	-	-	-	100%	-

*Pedestrians and Bicycles on Crosswalk. L: Left, R: Right, T: Thru, U: U-Turn

Lake and Racine TMC - TMC

Tue Mar 26, 2024

PM Peak (4 PM - 5 PM) - Overall Peak Hour

All Classes (Lights, Single-Unit Trucks, Articulated Trucks, Buses, Pedestrians, Bicycles on Road)

All Movements

ID: 1165692, Location: 41.885509, -87.656826



Provided by: Kenig Lindgren O'Hara Aboona, Inc.

9575 W. Higgins Rd., Suite 400,
Rosemont, IL, 60018, US

[N] Racine Avenue

Total: 318

In: 187 Out: 131

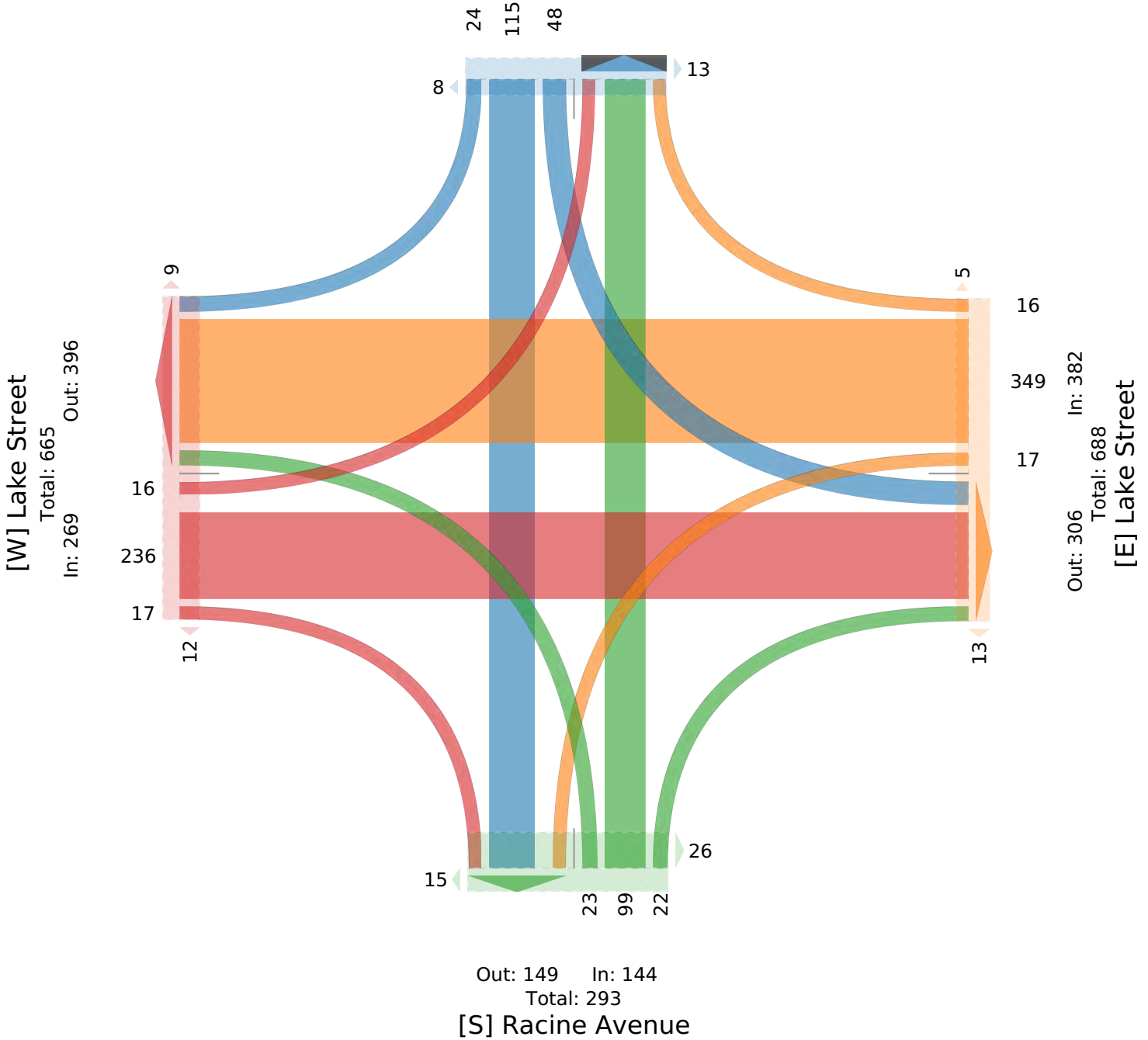

Lake Street and May Street TMC - TMC

Tue Mar 26, 2024

Full Length (7 AM-9 AM, 4 PM-8 PM)

All Classes (Lights, Single-Unit Trucks, Articulated Trucks, Buses, Pedestrians, Bicycles on Road)

All Movements

ID: 1165693, Location: 41.88552, -87.655628



Provided by: Kenig Lindgren O'Hara Aboona, Inc.
9575 W. Higgins Rd., Suite 400,
Rosemont, IL, 60018, US

Leg Direction	May Street Southbound						Lake Street Westbound						May Street Northbound						Lake Street Eastbound						
Time	R	T	L	U	App	Ped*	R	T	L	U	App	Ped*	R	T	L	U	App	Ped*	R	T	L	U	App	Ped*	Int
2024-03-26																									
7:00AM	0	10	5	0	15	3	1	47	3	0	51	0	1	12	3	0	16	3	5	43	6	1	55	1	137
7:15AM	1	9	2	0	12	9	3	47	2	0	52	1	1	12	0	0	13	5	4	55	1	0	60	1	137
7:30AM	2	12	1	0	15	4	6	45	2	0	53	5	2	20	6	0	28	8	6	68	2	0	76	2	172
7:45AM	2	9	1	0	12	5	6	35	5	0	46	2	1	12	5	0	18	10	2	71	4	0	77	0	153
Hourly Total	5	40	9	0	54	21	16	174	12	0	202	8	5	56	14	0	75	26	17	237	13	1	268	4	599
8:00AM	0	13	4	0	17	2	1	47	2	0	50	1	1	24	2	0	27	5	19	76	3	0	98	0	192
8:15AM	4	11	4	0	19	4	5	41	3	0	49	2	2	10	9	0	21	9	7	80	4	0	91	2	180
8:30AM	2	6	2	0	10	11	1	45	3	0	49	2	1	12	2	0	15	15	7	78	7	0	92	1	166
8:45AM	2	9	3	0	14	6	7	42	5	0	54	1	1	16	2	0	19	8	19	69	1	0	89	4	176
Hourly Total	8	39	13	0	60	23	14	175	13	0	202	6	5	62	15	0	82	37	52	303	15	0	370	7	714
4:00PM	6	13	2	0	21	6	21	77	3	0	101	4	5	31	5	0	41	16	8	63	2	0	73	1	236
4:15PM	7	10	4	0	21	6	4	92	4	0	100	1	1	33	6	0	40	14	8	67	2	0	77	3	238
4:30PM	4	12	2	0	18	9	12	72	3	0	87	1	1	55	3	0	59	9	10	62	7	0	79	1	243
4:45PM	4	16	2	0	22	12	12	97	5	0	114	2	2	54	6	0	62	15	8	64	4	0	76	2	274
Hourly Total	21	51	10	0	82	33	49	338	15	0	402	8	9	173	20	0	202	54	34	256	15	0	305	7	991
5:00PM	4	11	6	0	21	10	11	89	0	0	100	6	2	41	7	0	50	18	5	55	4	0	64	7	235
5:15PM	5	19	3	0	27	11	13	90	1	0	104	6	7	37	6	0	50	20	13	51	3	0	67	3	248
5:30PM	4	16	3	0	23	6	6	85	5	0	96	5	7	50	11	0	68	11	9	48	2	0	59	4	246
5:45PM	5	22	5	0	32	7	9	90	3	0	102	5	5	36	7	0	48	9	9	57	6	0	72	4	254
Hourly Total	18	68	17	0	103	34	39	354	9	0	402	22	21	164	31	0	216	58	36	211	15	0	262	18	983
6:00PM	2	13	5	0	20	8	8	66	3	0	77	4	5	45	9	0	59	5	7	43	5	0	55	0	211
6:15PM	5	16	1	0	22	3	7	62	4	0	73	0	2	33	7	0	42	14	8	57	7	0	72	3	209
6:30PM	6	21	1	0	28	8	5	63	5	0	73	1	2	30	4	0	36	7	13	50	3	0	66	0	203
6:45PM	5	9	4	0	18	2	5	76	2	0	83	0	3	29	7	0	39	3	5	54	1	0	60	4	200
Hourly Total	18	59	11	0	88	21	25	267	14	0	306	5	12	137	27	0	176	29	33	204	16	0	253	7	823
7:00PM	3	10	1	0	14	6	10	65	5	0	80	3	1	36	7	0	44	2	7	57	2	0	66	5	204
7:15PM	4	12	2	0	18	1	8	50	6	0	64	2	1	26	6	0	33	4	5	62	1	0	68	0	183
7:30PM	1	14	3	0	18	3	9	49	2	0	60	0	3	21	7	0	31	1	11	59	3	0	73	1	182
7:45PM	1	9	3	0	13	5	3	31	2	0	36	2	6	22	3	0	31	4	9	34	2	0	45	0	125
Hourly Total	9	45	9	0	63	15	30	195	15	0	240	7	11	105	23	0	139	11	32	212	8	0	252	6	694
Total	79	302	69	0	450	147	173	1503	78	0	1754	56	63	697	130	0	890	215	204	1423	82	1	1710	49	4804
% Approach	17.6%	67.1%	15.3%	0%	-	-	9.9%	85.7%	4.4%	0%	-	-	7.1%	78.3%	14.6%	0%	-	-	11.9%	83.2%	4.8%	0.1%	-	-	-
% Total	1.6%	6.3%	1.4%	0%	9.4%	-	3.6%	31.3%	1.6%	0%	36.5%	-	1.3%	14.5%	2.7%	0%	18.5%	-	4.2%	29.6%	1.7%	0%	35.6%	-	-
Lights	71	294	68	0	433	-	168	1435	76	0	1679	-	62	688	127	0	877	-	198	1354	78	1	1631	-	4620
% Lights	89.9%	97.4%	98.6%	0%	96.2%	-	97.1%	95.5%	97.4%	0%	95.7%	-	98.4%	98.7%	97.7%	0%	98.5%	-	97.1%	95.2%	95.1%	100%	95.4%	-	96.2%
Single-Unit Trucks	0	2	1	0	3	-	1	20	2	0	23	-	1	6	2	0	9	-	4	44	3	0	51	-	86
% Single-Unit Trucks	0%	0.7%	1.4%	0%	0.7%	-	0.6%	1.3%	2.6%	0%	1.3%	-	1.6%	0.9%	1.5%	0%	1.0%	-	2.0%	3.1%	3.7%	0%	3.0%	-	1.8%
Articulated Trucks	0	0	0	0	0	-	0	1	0	0	1	-	0	0	0	0	0	-	0	1	0	0	1	-	2
% Articulated Trucks	0%	0%	0%	0%	0%	-	0%	0.1%	0%	0%	0.1%	-	0%	0%	0%	0%	0%	-	0%	0.1%	0%	0%	0.1%	-	0%
Buses	6	2	0	0	8	-	1	0	0	0	1	-	0	0	0	0	0	-	1	0	0	0	1	-	10
% Buses	7.6%	0.7%	0%	0%	1.8%	-	0.6%	0%	0%	0%	0.1%	-	0%	0%	0%	0%	0%	-	0.5%	0%	0%	0%	0.1%	-	0.2%
Bicycles on Road	2	4	0	0	6	-	3	47	0	0	50	-	0	3	1	0	4	-	1	24	1	0	26	-	86
% Bicycles on Road	2.5%	1.3%	0%	0%	1.3%	-	1.7%	3.1%	0%	0%	2.9%	-	0%	0.4%	0.8%	0%	0.4%	-	0.5%	1.7%	1.2%	0%	1.5%	-	1.8%
Pedestrians	-	-	-	-	-	147	-	-	-	-	-	56	-	-	-	-	-	215	-	-	-	-	-	49	-
% Pedestrians	-	-	-	-	-	100%	-	-	-	-	-	100%	-	-	-	-	-	100%	-	-	-	-	-	100%	-

* Pedestrians and Bicycles on Crosswalk. L: Left, R: Right, T: Thru, U: U-Turn

Lake Street and May Street TMC - TMC

Tue Mar 26, 2024

Full Length (7 AM-9 AM, 4 PM-8 PM)

All Classes (Lights, Single-Unit Trucks, Articulated Trucks, Buses, Pedestrians, Bicycles on Road)

All Movements

ID: 1165693, Location: 41.88552, -87.655628



Provided by: Kenig Lindgren O'Hara Aboona, Inc.

9575 W. Higgins Rd., Suite 400,
Rosemont, IL, 60018, US

[N] May Street

Total: 1402

In: 450 Out: 952

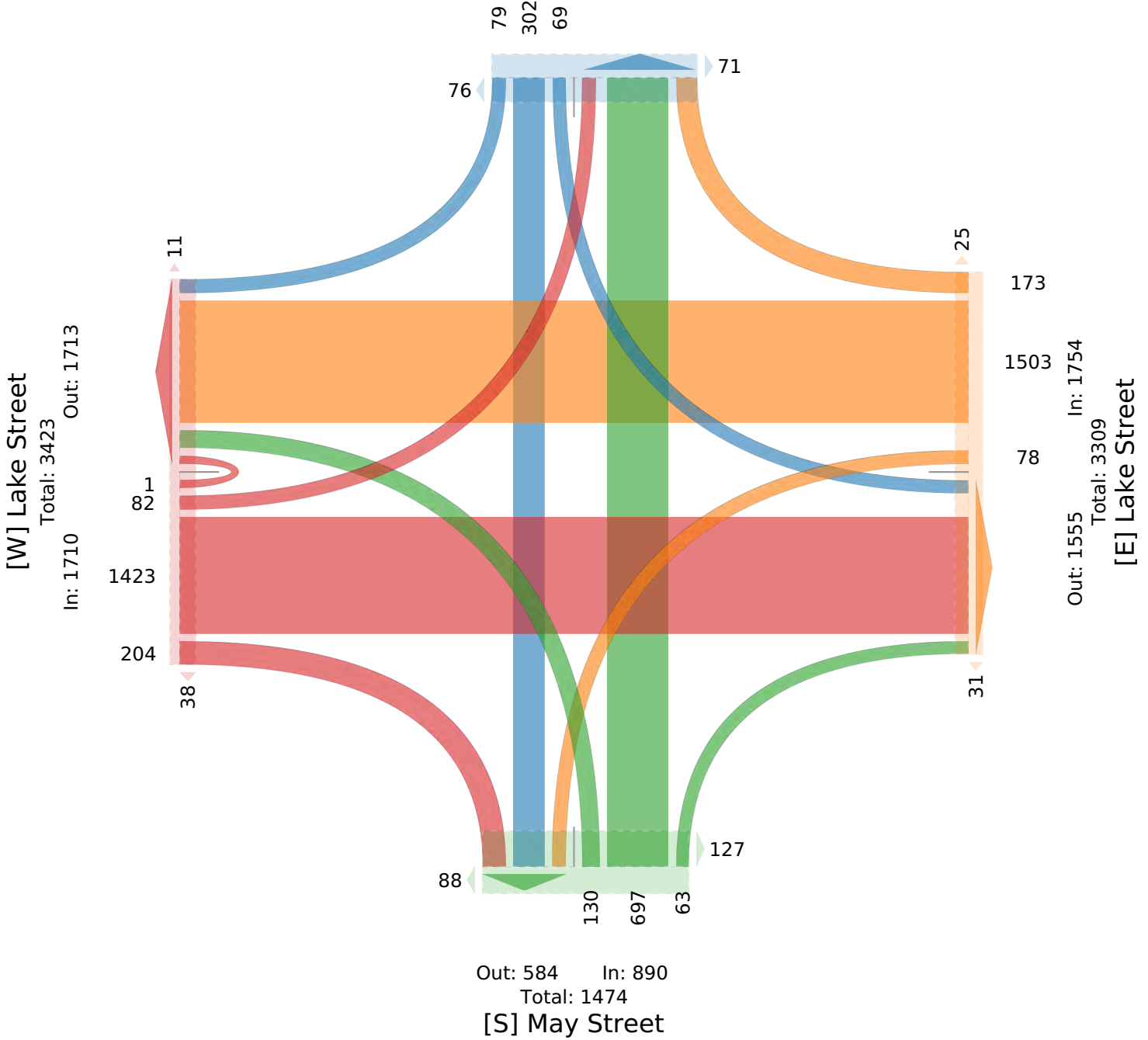

Lake Street and May Street TMC - TMC

Tue Mar 26, 2024

AM Peak (8 AM - 9 AM)

All Classes (Lights, Single-Unit Trucks, Articulated Trucks, Buses, Pedestrians, Bicycles on Road)

All Movements

ID: 1165693, Location: 41.88552, -87.655628



Provided by: Kenig Lindgren O'Hara Aboona, Inc.

9575 W. Higgins Rd., Suite 400, Rosemont, IL, 60018, US

Leg Direction	May Street Southbound						Lake Street Westbound						May Street Northbound						Lake Street Eastbound						
Time	R	T	L	U	App	Ped*	R	T	L	U	App	Ped*	R	T	L	U	App	Ped*	R	T	L	U	App	Ped*	Int
2024-03-26																									
8:00AM	0	13	4	0	17	2	1	47	2	0	50	1	1	24	2	0	27	5	19	76	3	0	98	0	192
8:15AM	4	11	4	0	19	4	5	41	3	0	49	2	2	10	9	0	21	9	7	80	4	0	91	2	180
8:30AM	2	6	2	0	10	11	1	45	3	0	49	2	1	12	2	0	15	15	7	78	7	0	92	1	166
8:45AM	2	9	3	0	14	6	7	42	5	0	54	1	1	16	2	0	19	8	19	69	1	0	89	4	176
Total	8	39	13	0	60	23	14	175	13	0	202	6	5	62	15	0	82	37	52	303	15	0	370	7	714
% Approach	13.3%	65.0%	21.7%	0%	-	-	6.9%	86.6%	6.4%	0%	-	-	6.1%	75.6%	18.3%	0%	-	-	14.1%	81.9%	4.1%	0%	-	-	-
% Total	1.1%	5.5%	1.8%	0%	8.4%	-	2.0%	24.5%	1.8%	0%	28.3%	-	0.7%	8.7%	2.1%	0%	11.5%	-	7.3%	42.4%	2.1%	0%	51.8%	-	-
PHF	0.500	0.712	0.813	-	0.763	-	0.500	0.918	0.650	-	0.942	-	0.625	0.646	0.417	-	0.759	-	0.671	0.940	0.536	-	0.936	-	0.920
Lights	8	37	13	0	58	-	13	162	13	0	188	-	5	60	14	0	79	-	49	277	14	0	340	-	665
% Lights	100%	94.9%	100%	0%	96.7%	-	92.9%	92.6%	100%	0%	93.1%	-	100%	96.8%	93.3%	0%	96.3%	-	94.2%	91.4%	93.3%	0%	91.9%	-	93.1%
Single-Unit Trucks	0	0	0	0	0	-	1	7	0	0	8	-	0	2	1	0	3	-	2	20	1	0	23	-	34
% Single-Unit Trucks	0%	0%	0%	0%	0%	-	7.1%	4.0%	0%	0%	4.0%	-	0%	3.2%	6.7%	0%	3.7%	-	3.8%	6.6%	6.7%	0%	6.2%	-	4.8%
Articulated Trucks	0	0	0	0	0	-	0	0	0	0	0	-	0	0	0	0	0	-	0	0	0	0	0	-	0
% Articulated Trucks	0%	0%	0%	0%	0%	-	0%	0%	0%	0%	0%	-	0%	0%	0%	0%	0%	-	0%	0%	0%	0%	0%	-	0%
Buses	0	0	0	0	0	-	0	0	0	0	0	-	0	0	0	0	0	-	0	0	0	0	0	-	0
% Buses	0%	0%	0%	0%	0%	-	0%	0%	0%	0%	0%	-	0%	0%	0%	0%	0%	-	0%	0%	0%	0%	0%	-	0%
Bicycles on Road	0	2	0	0	2	-	0	6	0	0	6	-	0	0	0	0	0	-	1	6	0	0	7	-	15
% Bicycles on Road	0%	5.1%	0%	0%	3.3%	-	0%	3.4%	0%	0%	3.0%	-	0%	0%	0%	0%	0%	-	1.9%	2.0%	0%	0%	1.9%	-	2.1%
Pedestrians	-	-	-	-	-	23	-	-	-	-	-	6	-	-	-	-	-	37	-	-	-	-	-	7	-
% Pedestrians	-	-	-	-	-	100%	-	-	-	-	-	100%	-	-	-	-	-	100%	-	-	-	-	-	100%	-

* Pedestrians and Bicycles on Crosswalk. L: Left, R: Right, T: Thru, U: U-Turn

Lake Street and May Street TMC - TMC

Tue Mar 26, 2024

AM Peak (8 AM - 9 AM)

All Classes (Lights, Single-Unit Trucks, Articulated Trucks, Buses, Pedestrians, Bicycles on Road)

All Movements

ID: 1165693, Location: 41.88552, -87.655628



Provided by: Kenig Lindgren O'Hara Aboona, Inc.

9575 W. Higgins Rd., Suite 400,
Rosemont, IL, 60018, US

[N] May Street

Total: 151

In: 60 Out: 91

8 39 13

14 9

[W] Lake Street

Total: 568
In: 370 Out: 198

15

303

52

7

21

15

62

5

Out: 104 In: 82

Total: 186

[S] May Street

Out: 321 In: 202
Total: 523
[E] Lake Street

14

175

13

1

5

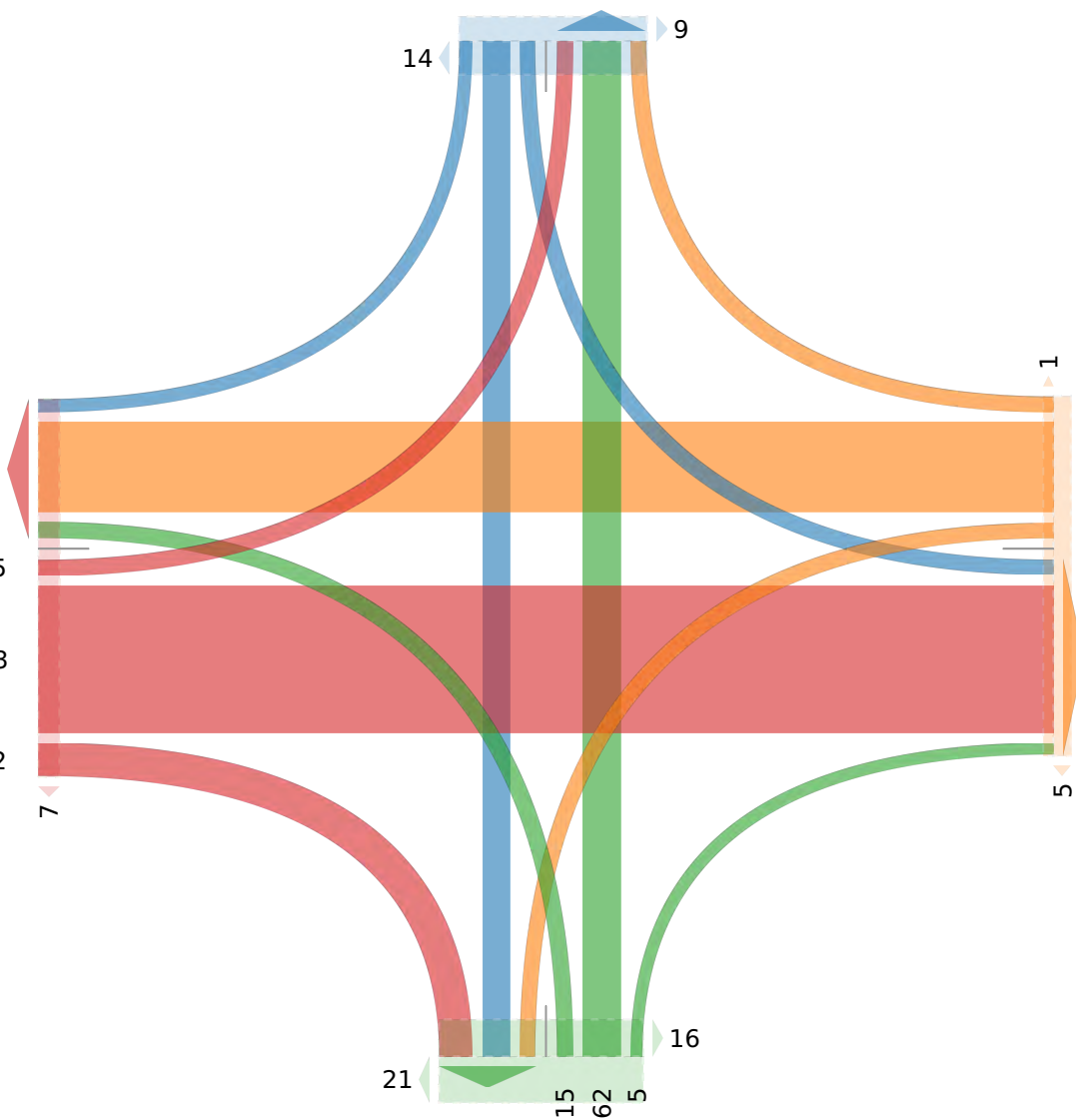

Lake Street and May Street TMC - TMC

Tue Mar 26, 2024

PM Peak (4:30 PM - 5:30 PM) - Overall Peak Hour

All Classes (Lights, Single-Unit Trucks, Articulated Trucks, Buses, Pedestrians, Bicycles on Road)

All Movements

ID: 1165693, Location: 41.88552, -87.655628



Provided by: Kenig Lindgren O'Hara Aboona, Inc.

9575 W. Higgins Rd., Suite 400, Rosemont, IL, 60018, US

Leg Direction	May Street Southbound						Lake Street Westbound						May Street Northbound						Lake Street Eastbound						
Time	R	T	L	U	App	Ped*	R	T	L	U	App	Ped*	R	T	L	U	App	Ped*	R	T	L	U	App	Ped*	Int
2024-03-26																									
4:30PM	4	12	2	0	18	9	12	72	3	0	87	1	1	55	3	0	59	9	10	62	7	0	79	1	243
4:45PM	4	16	2	0	22	12	12	97	5	0	114	2	2	54	6	0	62	15	8	64	4	0	76	2	274
5:00PM	4	11	6	0	21	10	11	89	0	0	100	6	2	41	7	0	50	18	5	55	4	0	64	7	235
5:15PM	5	19	3	0	27	11	13	90	1	0	104	6	7	37	6	0	50	20	13	51	3	0	67	3	248
Total	17	58	13	0	88	42	48	348	9	0	405	15	12	187	22	0	221	62	36	232	18	0	286	13	1000
% Approach	19.3%	65.9%	14.8%	0%	-	-	11.9%	85.9%	2.2%	0%	-	-	5.4%	84.6%	10.0%	0%	-	-	12.6%	81.1%	6.3%	0%	-	-	-
% Total	1.7%	5.8%	1.3%	0%	8.8%	-	4.8%	34.8%	0.9%	0%	40.5%	-	1.2%	18.7%	2.2%	0%	22.1%	-	3.6%	23.2%	1.8%	0%	28.6%	-	-
PHF	0.850	0.763	0.542	-	0.815	-	0.979	0.918	0.450	-	0.903	-	0.429	0.845	0.786	-	0.887	-	0.692	0.905	0.708	-	0.912	-	0.917
Lights	15	56	13	0	84	-	46	332	9	0	387	-	12	185	22	0	219	-	35	225	17	0	277	-	967
% Lights	88.2%	96.6%	100%	0%	95.5%	-	95.8%	95.4%	100%	0%	95.6%	-	100%	98.9%	100%	0%	99.1%	-	97.2%	97.0%	94.4%	0%	96.9%	-	96.7%
Single-Unit Trucks	0	1	0	0	1	-	0	2	0	0	2	-	0	1	0	0	1	-	0	3	0	0	3	-	7
% Single-Unit Trucks	0%	1.7%	0%	0%	1.1%	-	0%	0.6%	0%	0%	0.5%	-	0%	0.5%	0%	0%	0.5%	-	0%	1.3%	0%	0%	1.0%	-	0.7%
Articulated Trucks	0	0	0	0	0	-	0	0	0	0	0	-	0	0	0	0	0	-	0	0	0	0	0	-	0
% Articulated Trucks	0%	0%	0%	0%	0%	-	0%	0%	0%	0%	0%	-	0%	0%	0%	0%	0%	-	0%	0%	0%	0%	0%	-	0%
Buses	2	1	0	0	3	-	1	0	0	0	1	-	0	0	0	0	0	-	1	0	0	0	1	-	5
% Buses	11.8%	1.7%	0%	0%	3.4%	-	2.1%	0%	0%	0%	0.2%	-	0%	0%	0%	0%	0%	-	2.8%	0%	0%	0%	0.3%	-	0.5%
Bicycles on Road	0	0	0	0	0	-	1	14	0	0	15	-	0	1	0	0	1	-	0	4	1	0	5	-	21
% Bicycles on Road	0%	0%	0%	0%	0%	-	2.1%	4.0%	0%	0%	3.7%	-	0%	0.5%	0%	0%	0.5%	-	0%	1.7%	5.6%	0%	1.7%	-	2.1%
Pedestrians	-	-	-	-	-	42	-	-	-	-	-	15	-	-	-	-	-	62	-	-	-	-	-	13	-
% Pedestrians	-	-	-	-	-	100%	-	-	-	-	-	100%	-	-	-	-	-	100%	-	-	-	-	-	100%	-

* Pedestrians and Bicycles on Crosswalk. L: Left, R: Right, T: Thru, U: U-Turn

Lake Street and May Street TMC - TMC

Tue Mar 26, 2024

PM Peak (4:30 PM - 5:30 PM) - Overall Peak Hour

All Classes (Lights, Single-Unit Trucks, Articulated Trucks, Buses, Pedestrians, Bicycles on Road)

All Movements

ID: 1165693, Location: 41.88552, -87.655628



Provided by: Kenig Lindgren O'Hara Aboona, Inc.

9575 W. Higgins Rd., Suite 400,
Rosemont, IL, 60018, US

[N] May Street

Total: 341

In: 88 Out: 253

17 58 13

21 21

[W] Lake Street

Total: 673
In: 286 Out: 387

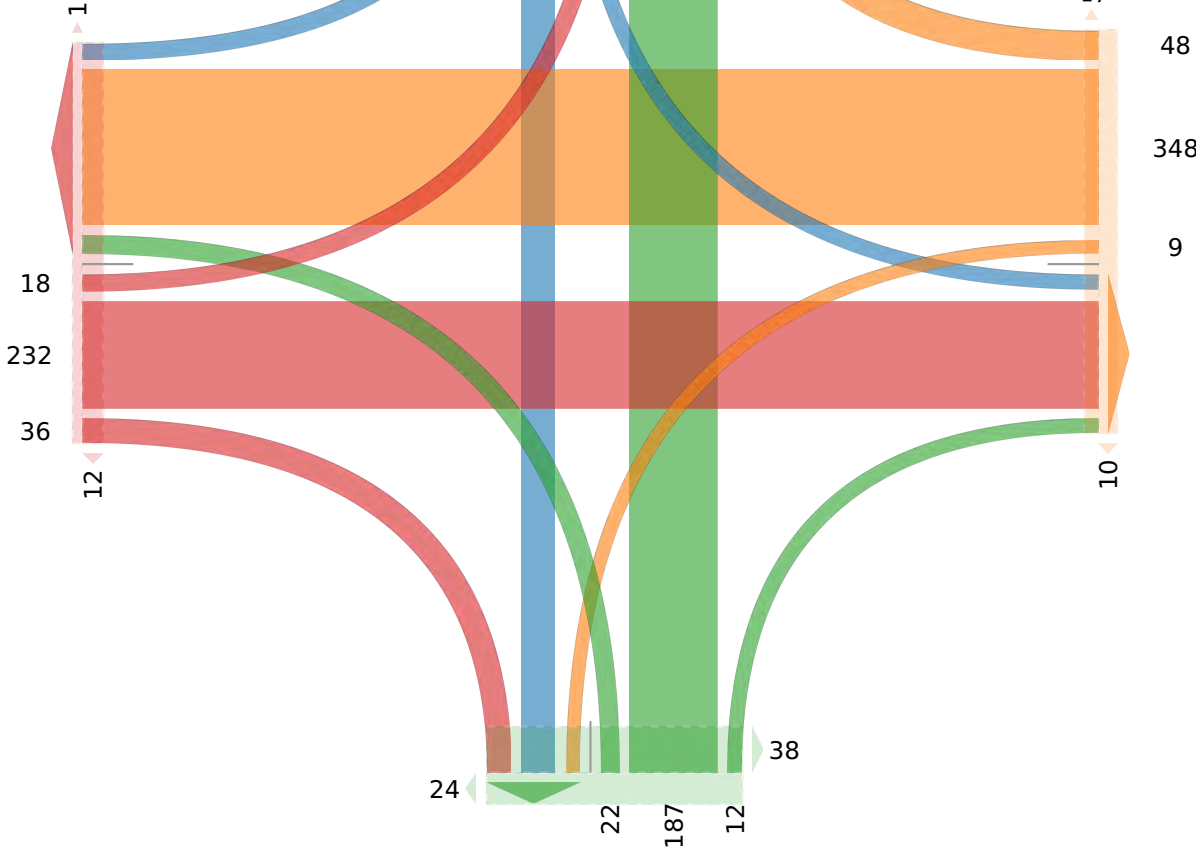

Out: 257 In: 405
Total: 662
[E] Lake Street

Out: 103 In: 221
Total: 324
[S] May Street

May Street with Fulton Street TMC - TMC

Wed Mar 20, 2024

Full Length (4 PM-6 PM, 7 AM-9 AM)

All Classes (Lights, Single-Unit Trucks, Articulated Trucks, Buses, Pedestrians, Bicycles on Road)

All Movements

ID: 1165715, Location: 41.88669, -87.655668



Provided by: Kenig Lindgren O'Hara Aboona, Inc.

9575 W. Higgins Rd., Suite 400, Rosemont, IL, 60018, US

Leg Direction	May Street Southbound						Fulton Street Westbound						May Street Northbound						Fulton Street Eastbound						Int
	R	T	L	U	App	Ped*	R	T	L	U	App	Ped*	R	T	L	U	App	Ped*	R	T	L	U	App	Ped*	
2024-03-20 4:00PM	4	16	0	0	20	16	6	46	1	0	53	8	0	36	5	1	42	9	0	1	0	0	1	1	116
4:15PM	2	29	0	0	31	19	12	33	3	0	48	2	0	35	5	0	40	9	0	0	0	0	0	2	119
4:30PM	1	26	0	0	27	21	11	44	4	0	59	1	0	101	12	0	113	6	0	0	0	0	0	0	199
4:45PM	1	25	0	0	26	20	3	45	0	0	48	4	0	62	7	0	69	8	0	1	0	0	1	1	144
Hourly Total	8	96	0	0	104	76	32	168	8	0	208	15	0	234	29	1	264	32	0	2	0	0	2	4	578
5:00PM	4	24	1	0	29	31	7	40	3	0	50	9	0	53	9	0	62	12	0	0	0	0	0	7	141
5:15PM	4	23	0	0	27	21	13	49	5	0	67	8	0	89	6	0	95	15	0	0	0	0	0	2	189
5:30PM	0	20	0	0	20	22	8	48	4	0	60	7	0	80	16	0	96	10	0	1	0	0	1	4	177
5:45PM	1	22	0	0	23	24	5	39	2	0	46	6	0	46	7	0	53	17	0	1	0	0	1	1	123
Hourly Total	9	89	1	0	99	98	33	176	14	0	223	30	0	268	38	0	306	54	0	2	0	0	2	14	630
2024-03-21 7:00AM	1	10	0	0	11	3	3	11	1	0	15	1	0	18	3	0	21	3	0	0	0	0	0	2	47
7:15AM	4	11	0	0	15	9	5	11	3	0	19	2	0	15	4	0	19	7	0	0	0	0	0	3	53
7:30AM	7	14	0	0	21	12	7	10	1	0	18	3	0	19	2	0	21	6	0	0	0	0	0	1	60
7:45AM	4	15	0	0	19	19	5	14	2	0	21	4	0	18	1	0	19	9	0	1	0	0	1	1	60
Hourly Total	16	50	0	0	66	43	20	46	7	0	73	10	0	70	10	0	80	25	0	1	0	0	1	7	220
8:00AM	2	17	0	0	19	14	0	17	3	0	20	4	0	28	7	0	35	10	0	1	0	0	1	0	75
8:15AM	1	25	0	0	26	13	4	18	2	0	24	0	0	29	6	1	36	9	0	1	0	0	1	2	87
8:30AM	3	23	0	0	26	19	3	19	4	0	26	4	0	26	3	0	29	13	0	1	0	0	1	1	82
8:45AM	2	29	0	0	31	17	8	14	4	0	26	2	0	13	7	1	21	8	0	2	0	0	2	0	80
Hourly Total	8	94	0	0	102	63	15	68	13	0	96	10	0	96	23	2	121	40	0	5	0	0	5	3	324
Total	41	329	1	0	371	280	100	458	42	0	600	65	0	668	100	3	771	151	0	10	0	0	10	28	1752
% Approach	11.1%	88.7%	0.3%	0%	-	-	16.7%	76.3%	7.0%	0%	-	-	0%	86.6%	13.0%	0.4%	-	-	0%	100%	0%	0%	-	-	-
% Total	2.3%	18.8%	0.1%	0%	21.2%	-	5.7%	26.1%	2.4%	0%	34.2%	-	0%	38.1%	5.7%	0.2%	44.0%	-	0%	0.6%	0%	0%	0.6%	-	-
Lights	36	299	0	0	335	-	93	394	40	0	527	-	0	650	92	3	745	-	0	0	0	0	0	-	1607
% Lights	87.8%	90.9%	0%	0%	90.3%	-	93.0%	86.0%	95.2%	0%	87.8%	-	0%	97.3%	92.0%	100%	96.6%	-	0%	0%	0%	0%	0%	-	91.7%
Single-Unit Trucks	4	9	0	0	13	-	4	22	1	0	27	-	0	10	4	0	14	-	0	0	0	0	0	-	54
% Single-Unit Trucks	9.8%	2.7%	0%	0%	3.5%	-	4.0%	4.8%	2.4%	0%	4.5%	-	0%	1.5%	4.0%	0%	1.8%	-	0%	0%	0%	0%	0%	-	3.1%
Articulated Trucks	0	0	0	0	0	-	0	2	0	0	2	-	0	1	2	0	3	-	0	0	0	0	0	-	5
% Articulated Trucks	0%	0%	0%	0%	0%	-	0%	0.4%	0%	0%	0.3%	-	0%	0.1%	2.0%	0%	0.4%	-	0%	0%	0%	0%	0%	-	0.3%
Buses	0	17	0	0	17	-	1	14	0	0	15	-	0	2	1	0	3	-	0	0	0	0	0	-	35
% Buses	0%	5.2%	0%	0%	4.6%	-	1.0%	3.1%	0%	0%	2.5%	-	0%	0.3%	1.0%	0%	0.4%	-	0%	0%	0%	0%	0%	-	2.0%
Bicycles on Road	1	4	1	0	6	-	2	26	1	0	29	-	0	5	1	0	6	-	0	10	0	0	10	-	51
% Bicycles on Road	2.4%	1.2%	100%	0%	1.6%	-	2.0%	5.7%	2.4%	0%	4.8%	-	0%	0.7%	1.0%	0%	0.8%	-	0%	100%	0%	0%	100%	-	2.9%
Pedestrians	-	-	-	-	-	280	-	-	-	-	65	-	-	-	-	151	-	-	-	-	-	28	-		
% Pedestrians	-	-	-	-	-	100%	-	-	-	-	100%	-	-	-	-	100%	-	-	-	-	-	100%	-		

*Pedestrians and Bicycles on Crosswalk. L: Left, R: Right, T: Thru, U: U-Turn

May Street with Fulton Street TMC - TMC

Wed Mar 20, 2024

Full Length (4 PM-6 PM, 7 AM-9 AM)

All Classes (Lights, Single-Unit Trucks, Articulated Trucks, Buses, Pedestrians, Bicycles on Road)

All Movements

ID: 1165715, Location: 41.88669, -87.655668



Provided by: Kenig Lindgren O'Hara Aboona, Inc.

9575 W. Higgins Rd., Suite 400,
Rosemont, IL, 60018, US

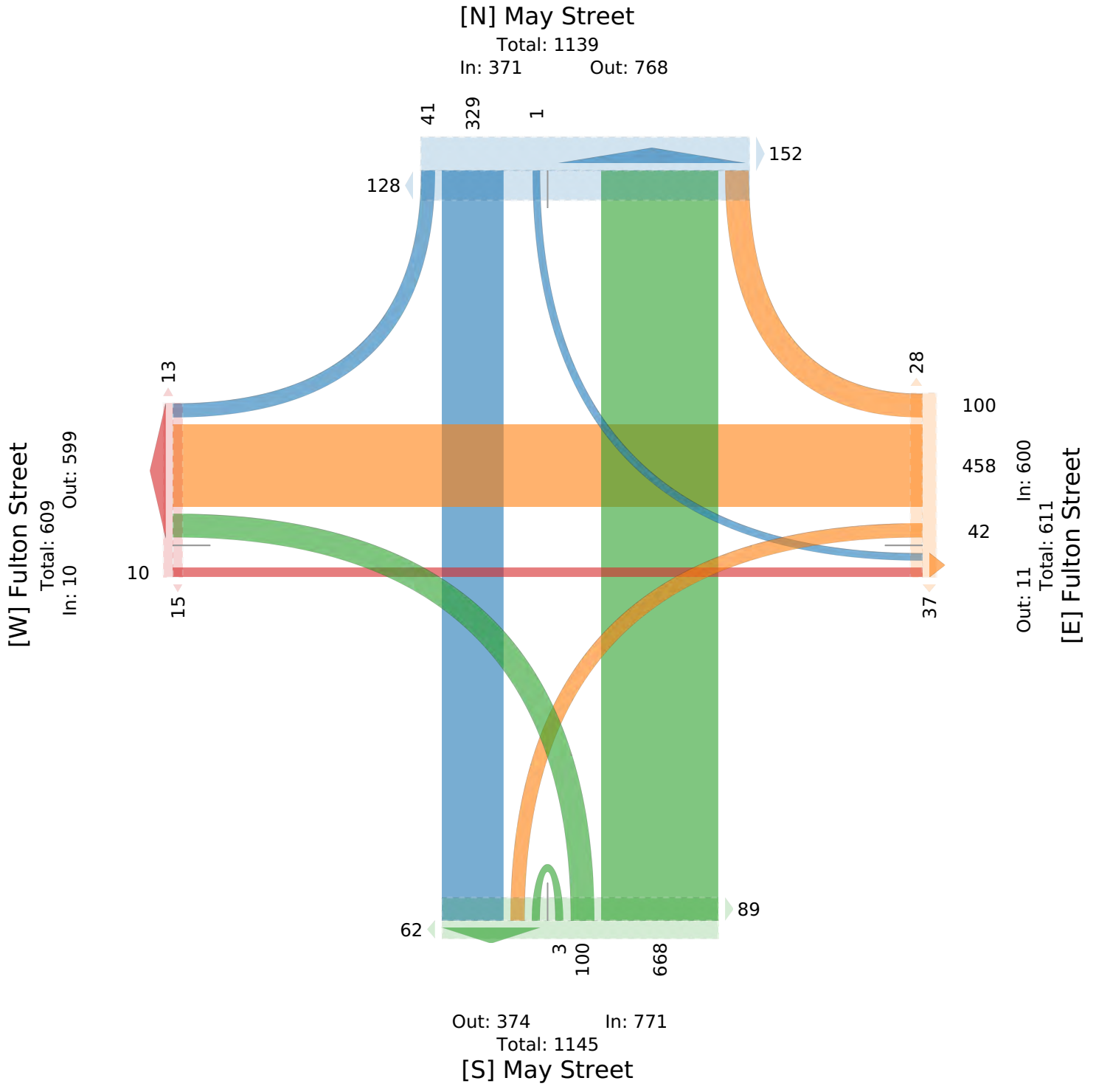

May Street with Fulton Street TMC - TMC

Wed Mar 20, 2024

PM Peak (Mar 20 2024 4:30PM - 5:30 PM) - Overall Peak Hour

All Classes (Lights, Single-Unit Trucks, Articulated Trucks, Buses, Pedestrians, Bicycles on Road)

All Movements

ID: 1165715, Location: 41.88669, -87.655668



Provided by: Kenig Lindgren O'Hara Aboona, Inc.

9575 W. Higgins Rd., Suite 400,
Rosemont, IL, 60018, US

Leg Direction	May Street Southbound						Fulton Street Westbound						May Street Northbound						Fulton Street Eastbound						
Time	R	T	L	U	App	Ped*	R	T	L	U	App	Ped*	R	T	L	U	App	Ped*	R	T	L	U	App	Ped*	Int
2024-03-20 4:30PM	1	26	0	0	27	21	11	44	4	0	59	1	0	101	12	0	113	6	0	0	0	0	0	0	199
4:45PM	1	25	0	0	26	20	3	45	0	0	48	4	0	62	7	0	69	8	0	1	0	0	1	1	144
5:00PM	4	24	1	0	29	31	7	40	3	0	50	9	0	53	9	0	62	12	0	0	0	0	0	7	141
5:15PM	4	23	0	0	27	21	13	49	5	0	67	8	0	89	6	0	95	15	0	0	0	0	0	2	189
Total	10	98	1	0	109	93	34	178	12	0	224	22	0	305	34	0	339	41	0	1	0	0	1	10	673
% Approach	9.2%	89.9%	0.9%	0%	-	-	15.2%	79.5%	5.4%	0%	-	-	0%	90.0%	10.0%	0%	-	-	0%	100%	0%	0%	-	-	-
% Total	1.5%	14.6%	0.1%	0%	16.2%	-	5.1%	26.4%	1.8%	0%	33.3%	-	0%	45.3%	5.1%	0%	50.4%	-	0%	0.1%	0%	0%	0.1%	-	-
PHF	0.625	0.970	-	-	0.955	-	0.688	0.885	0.600	-	0.827	-	-	0.748	0.708	-	0.743	-	-	-	-	-	-	-	0.835
Lights	9	89	0	0	98	-	32	157	11	0	200	-	0	299	33	0	332	-	0	0	0	0	0	-	630
% Lights	90.0%	90.8%	0%	0%	89.9%	-	94.1%	88.2%	91.7%	0%	89.3%	-	0%	98.0%	97.1%	0%	97.9%	-	0%	0%	0%	0%	0%	-	93.6%
Single-Unit Trucks	1	0	0	0	1	-	0	6	1	0	7	-	0	2	1	0	3	-	0	0	0	0	0	-	11
% Single-Unit Trucks	10.0%	0%	0%	0%	0.9%	-	0%	3.4%	8.3%	0%	3.1%	-	0%	0.7%	2.9%	0%	0.9%	-	0%	0%	0%	0%	0%	-	1.6%
Articulated Trucks	0	0	0	0	0	-	0	1	0	0	1	-	0	0	0	0	0	-	0	0	0	0	0	-	1
% Articulated Trucks	0%	0%	0%	0%	0%	-	0%	0.6%	0%	0%	0.4%	-	0%	0%	0%	0%	0%	-	0%	0%	0%	0%	0%	-	0.1%
Buses	0	8	0	0	8	-	1	6	0	0	7	-	0	1	0	0	1	-	0	0	0	0	0	-	16
% Buses	0%	8.2%	0%	0%	7.3%	-	2.9%	3.4%	0%	0%	3.1%	-	0%	0.3%	0%	0%	0.3%	-	0%	0%	0%	0%	0%	-	2.4%
Bicycles on Road	0	1	1	0	2	-	1	8	0	0	9	-	0	3	0	0	3	-	0	1	0	0	1	-	15
% Bicycles on Road	0%	1.0%	100%	0%	1.8%	-	2.9%	4.5%	0%	0%	4.0%	-	0%	1.0%	0%	0%	0.9%	-	0%	100%	0%	0%	100%	-	2.2%
Pedestrians	-	-	-	-	-	93	-	-	-	-	-	22	-	-	-	-	-	41	-	-	-	-	-	10	
% Pedestrians	-	-	-	-	-	100%	-	-	-	-	-	100%	-	-	-	-	-	100%	-	-	-	-	-	100%	

* Pedestrians and Bicycles on Crosswalk. L: Left, R: Right, T: Thru, U: U-Turn

May Street with Fulton Street TMC - TMC

Wed Mar 20, 2024

PM Peak (Mar 20 2024 4:30PM - 5:30 PM) - Overall Peak Hour

All Classes (Lights, Single-Unit Trucks, Articulated Trucks, Buses, Pedestrians, Bicycles on Road)

All Movements

ID: 1165715, Location: 41.88669, -87.655668



Provided by: Kenig Lindgren O'Hara Aboona, Inc.

9575 W. Higgins Rd., Suite 400,
Rosemont, IL, 60018, US

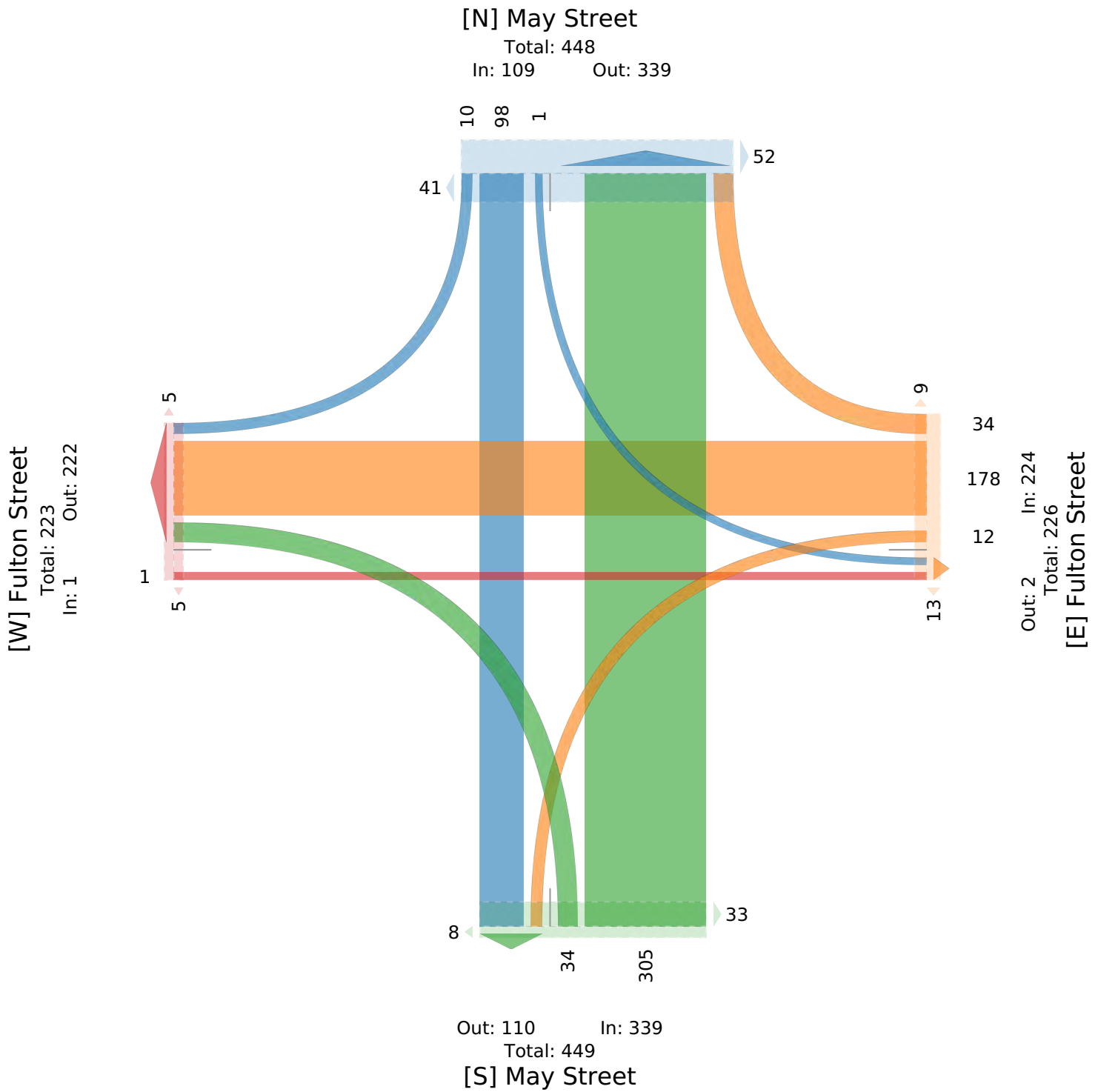

May Street with Fulton Street TMC - TMC

Thu Mar 21, 2024

AM Peak (Mar 21 2024 8AM - 9 AM)

All Classes (Lights, Single-Unit Trucks, Articulated Trucks, Buses, Pedestrians, Bicycles on Road)

All Movements

ID: 1165715, Location: 41.88669, -87.655668



Provided by: Kenig Lindgren O'Hara Aboona, Inc.

9575 W. Higgins Rd., Suite 400,
Rosemont, IL, 60018, US

Leg Direction	May Street Southbound						Fulton Street Westbound						May Street Northbound						Fulton Street Eastbound						
Time	R	T	L	U	App	Ped*	R	T	L	U	App	Ped*	R	T	L	U	App	Ped*	R	T	L	U	App	Ped*	Int
2024-03-21 8:00AM	2	17	0	0	19	14	0	17	3	0	20	4	0	28	7	0	35	10	0	1	0	0	1	0	75
8:15AM	1	25	0	0	26	13	4	18	2	0	24	0	0	29	6	1	36	9	0	1	0	0	1	2	87
8:30AM	3	23	0	0	26	19	3	19	4	0	26	4	0	26	3	0	29	13	0	1	0	0	1	1	82
8:45AM	2	29	0	0	31	17	8	14	4	0	26	2	0	13	7	1	21	8	0	2	0	0	2	0	80
Total	8	94	0	0	102	63	15	68	13	0	96	10	0	96	23	2	121	40	0	5	0	0	5	3	324
% Approach	7.8%	92.2%	0%	0%	-	-	15.6%	70.8%	13.5%	0%	-	-	0%	79.3%	19.0%	1.7%	-	-	0%	100%	0%	0%	-	-	-
% Total	2.5%	29.0%	0%	0%	31.5%	-	4.6%	21.0%	4.0%	0%	29.6%	-	0%	29.6%	7.1%	0.6%	37.3%	-	0%	1.5%	0%	0%	1.5%	-	-
PHF	0.667	0.802	-	-	0.815	-	0.469	0.829	0.750	-	0.865	-	-	0.819	0.821	0.500	0.833	-	-	-	-	-	-	-	0.926
Lights	7	87	0	0	94	-	13	56	12	0	81	-	0	90	19	2	111	-	0	0	0	0	0	-	286
% Lights	87.5%	92.6%	0%	0%	92.2%	-	86.7%	82.4%	92.3%	0%	84.4%	-	0%	93.8%	82.6%	100%	91.7%	-	0%	0%	0%	0%	0%	-	88.3%
Single-Unit Trucks	1	6	0	0	7	-	2	6	0	0	8	-	0	4	2	0	6	-	0	0	0	0	0	-	21
% Single-Unit Trucks	12.5%	6.4%	0%	0%	6.9%	-	13.3%	8.8%	0%	0%	8.3%	-	0%	4.2%	8.7%	0%	5.0%	-	0%	0%	0%	0%	0%	-	6.5%
Articulated Trucks	0	0	0	0	0	-	0	1	0	0	1	-	0	1	2	0	3	-	0	0	0	0	0	-	4
% Articulated Trucks	0%	0%	0%	0%	0%	-	0%	1.5%	0%	0%	1.0%	-	0%	1.0%	8.7%	0%	2.5%	-	0%	0%	0%	0%	0%	-	1.2%
Buses	0	0	0	0	0	-	0	0	0	0	0	-	0	0	0	0	0	-	0	0	0	0	0	-	0
% Buses	0%	0%	0%	0%	0%	-	0%	0%	0%	0%	0%	-	0%	0%	0%	0%	0%	-	0%	0%	0%	0%	0%	-	0%
Bicycles on Road	0	1	0	0	1	-	0	5	1	0	6	-	0	1	0	0	1	-	0	5	0	0	5	-	13
% Bicycles on Road	0%	1.1%	0%	0%	1.0%	-	0%	7.4%	7.7%	0%	6.3%	-	0%	1.0%	0%	0%	0.8%	-	0%	100%	0%	0%	100%	-	4.0%
Pedestrians	-	-	-	-	-	63	-	-	-	-	-	10	-	-	-	-	-	40	-	-	-	-	-	3	
% Pedestrians	-	-	-	-	-	100%	-	-	-	-	-	100%	-	-	-	-	-	100%	-	-	-	-	-	100%	

* Pedestrians and Bicycles on Crosswalk. L: Left, R: Right, T: Thru, U: U-Turn

May Street with Fulton Street TMC - TMC

Thu Mar 21, 2024

AM Peak (Mar 21 2024 8AM - 9 AM)

All Classes (Lights, Single-Unit Trucks, Articulated Trucks, Buses, Pedestrians, Bicycles on Road)

All Movements

ID: 1165715, Location: 41.88669, -87.655668



Provided by: Kenig Lindgren O'Hara Aboona, Inc.

9575 W. Higgins Rd., Suite 400,
Rosemont, IL, 60018, US

[N] May Street

Total: 213

In: 102 Out: 111

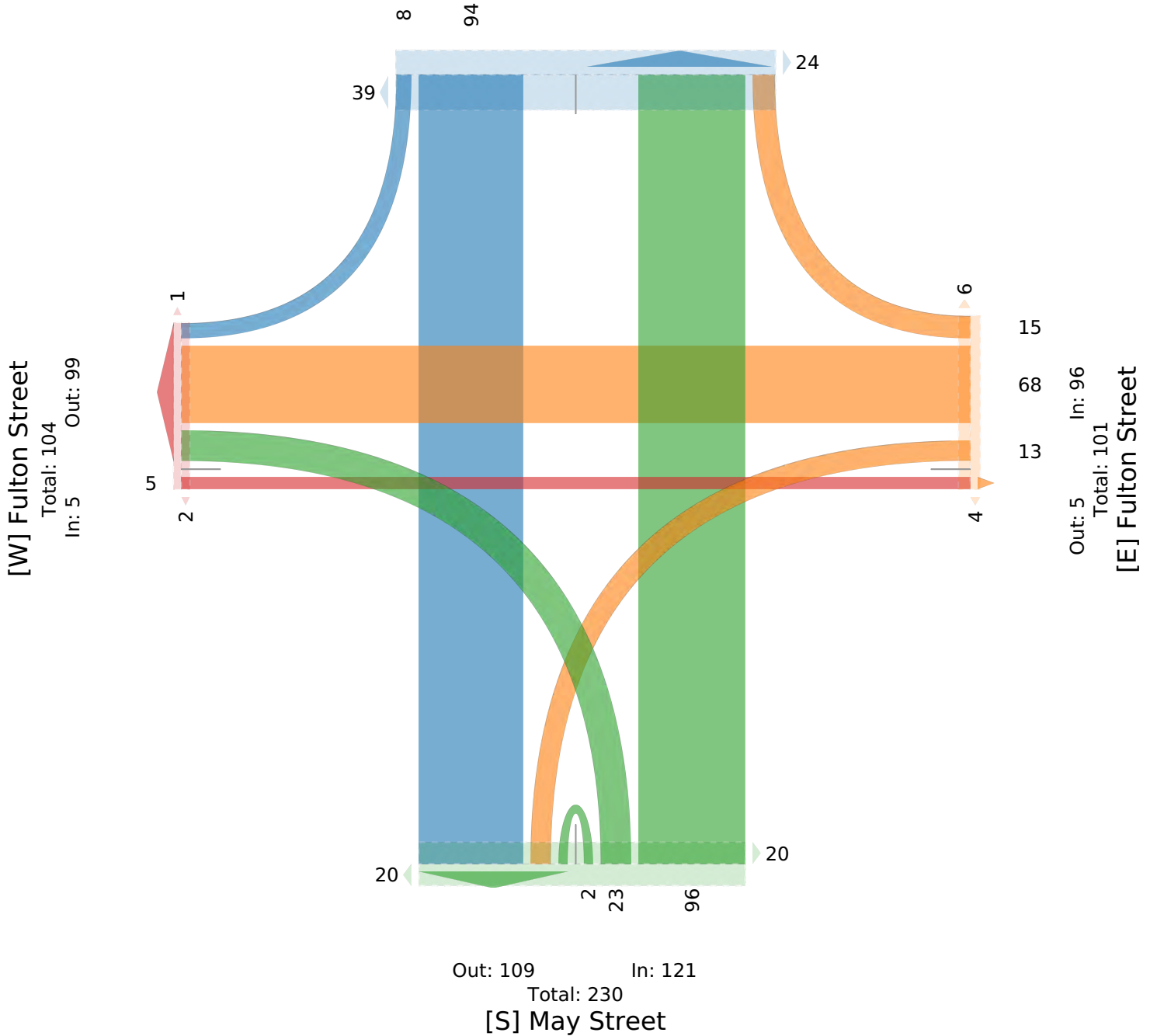

Racine Avenue and Fulton Street TMC - TMC

Wed Mar 20, 2024

Full Length (4 PM-6 PM, 7 AM-9 AM)

All Classes (Lights, Single-Unit Trucks, Articulated Trucks, Buses, Pedestrians, Bicycles on Road)

All Movements

ID: 1165713, Location: 41.886711, -87.656842



Provided by: Kenig Lindgren O'Hara Aboona, Inc.

9575 W. Higgins Rd., Suite 400, Rosemont, IL, 60018, US

Leg Direction	Racine Avenue Southbound						Fulton Street Westbound						Racine Avenue Northbound						Fulton Street Eastbound						
Time	R	T	L	U	App	Ped*	R	T	L	U	App	Ped*	R	T	L	U	App	Ped*	R	T	L	U	App	Ped*	Int
2024-03-20																									
4:00PM	4	36	0	0	40	20	14	38	2	0	54	12	0	33	6	0	39	13	10	1	5	0	16	16	149
4:15PM	5	47	0	0	52	16	10	23	5	0	38	10	0	29	2	0	31	8	7	0	7	0	14	6	135
4:30PM	2	32	0	0	34	16	17	40	4	0	61	11	0	45	3	0	48	15	10	1	10	0	21	4	164
4:45PM	4	31	0	0	35	17	20	29	6	0	55	6	0	76	7	0	83	1	7	0	14	0	21	8	194
Hourly Total	15	146	0	0	161	69	61	130	17	0	208	39	0	183	18	0	201	37	34	2	36	0	72	34	642
5:00PM	10	38	0	0	48	32	14	38	3	0	55	15	0	45	8	0	53	8	16	0	12	0	28	8	184
5:15PM	2	40	0	0	42	21	13	38	5	0	56	6	0	29	4	2	35	8	8	0	17	0	25	10	158
5:30PM	4	29	0	0	33	20	18	41	3	0	62	13	0	44	6	0	50	5	7	1	15	0	23	5	168
5:45PM	5	39	0	0	44	16	22	25	2	0	49	4	0	49	3	1	53	3	9	1	13	0	23	4	169
Hourly Total	21	146	0	0	167	89	67	142	13	0	222	38	0	167	21	3	191	24	40	2	57	0	99	27	679
2024-03-21																									
7:00AM	4	26	0	0	30	3	2	7	3	0	12	3	0	10	2	0	12	0	5	0	3	0	8	1	62
7:15AM	4	33	0	0	37	9	5	11	1	0	17	4	0	15	6	0	21	3	9	0	3	0	12	5	87
7:30AM	3	44	0	0	47	10	2	15	4	0	21	9	1	19	3	1	24	4	5	0	8	0	13	4	105
7:45AM	1	48	0	0	49	17	4	15	0	0	19	6	0	21	6	0	27	4	8	1	7	0	16	3	111
Hourly Total	12	151	0	0	163	39	13	48	8	0	69	22	1	65	17	1	84	11	27	1	21	0	49	13	365
8:00AM	3	59	0	0	62	15	5	15	5	0	25	5	0	24	3	0	27	4	14	1	5	0	20	5	134
8:15AM	5	39	0	0	44	11	4	16	5	0	25	8	0	18	2	0	20	4	10	1	7	0	18	5	107
8:30AM	2	40	0	0	42	25	6	16	3	0	25	7	1	21	3	0	25	4	13	0	7	0	20	8	112
8:45AM	2	42	0	0	44	18	5	16	1	0	22	6	0	20	2	0	22	7	8	2	5	0	15	10	103
Hourly Total	12	180	0	0	192	69	20	63	14	0	97	26	1	83	10	0	94	19	45	4	24	0	73	28	456
Total	60	623	0	0	683	266	161	383	52	0	596	125	2	498	66	4	570	91	146	9	138	0	293	102	2142
% Approach	8.8%	91.2%	0%	0%	-	-	27.0%	64.3%	8.7%	0%	-	-	0.4%	87.4%	11.6%	0.7%	-	-	49.8%	3.1%	47.1%	0%	-	-	-
% Total	2.8%	29.1%	0%	0%	31.9%	-	7.5%	17.9%	2.4%	0%	27.8%	-	0.1%	23.2%	3.1%	0.2%	26.6%	-	6.8%	0.4%	6.4%	0%	13.7%	-	-
Lights	48	583	0	0	631	-	158	322	44	0	524	-	1	479	55	4	539	-	124	0	133	0	257	-	1951
% Lights	80.0%	93.6%	0%	0%	92.4%	-	98.1%	84.1%	84.6%	0%	87.9%	-	50.0%	96.2%	83.3%	100%	94.6%	-	84.9%	0%	96.4%	0%	87.7%	-	91.1%
Single-Unit Trucks	2	5	0	0	7	-	2	24	3	0	29	-	0	4	1	0	5	-	2	0	2	0	4	-	45
% Single-Unit Trucks	3.3%	0.8%	0%	0%	1.0%	-	1.2%	6.3%	5.8%	0%	4.9%	-	0%	0.8%	1.5%	0%	0.9%	-	1.4%	0%	1.4%	0%	1.4%	-	2.1%
Articulated Trucks	2	0	0	0	2	-	0	3	0	0	3	-	0	0	0	0	0	-	0	0	0	0	0	-	5
% Articulated Trucks	3.3%	0%	0%	0%	0.3%	-	0%	0.8%	0%	0%	0.5%	-	0%	0%	0%	0%	0%	-	0%	0%	0%	0%	0%	-	0.2%
Buses	4	9	0	0	13	-	0	13	3	0	16	-	0	1	9	0	10	-	13	0	1	0	14	-	53
% Buses	6.7%	1.4%	0%	0%	1.9%	-	0%	3.4%	5.8%	0%	2.7%	-	0%	0.2%	13.6%	0%	1.8%	-	8.9%	0%	0.7%	0%	4.8%	-	2.5%
Bicycles on Road	4	26	0	0	30	-	1	21	2	0	24	-	1	14	1	0	16	-	7	9	2	0	18	-	88
% Bicycles on Road	6.7%	4.2%	0%	0%	4.4%	-	0.6%	5.5%	3.8%	0%	4.0%	-	50.0%	2.8%	1.5%	0%	2.8%	-	4.8%	100%	1.4%	0%	6.1%	-	4.1%
Pedestrians	-	-	-	-	-	266	-	-	-	-	-	125	-	-	-	-	-	91	-	-	-	-	-	102	-
% Pedestrians	-	-	-	-	-	100%	-	-	-	-	-	100%	-	-	-	-	-	100%	-	-	-	-	-	100%	-

* Pedestrians and Bicycles on Crosswalk. L: Left, R: Right, T: Thru, U: U-Turn

Racine Avenue and Fulton Street TMC - TMC

Wed Mar 20, 2024

Full Length (4 PM-6 PM, 7 AM-9 AM)

All Classes (Lights, Single-Unit Trucks, Articulated Trucks, Buses, Pedestrians, Bicycles on Road)

All Movements

ID: 1165713, Location: 41.886711, -87.656842



Provided by: Kenig Lindgren O'Hara Aboona, Inc.

9575 W. Higgins Rd., Suite 400,
Rosemont, IL, 60018, US

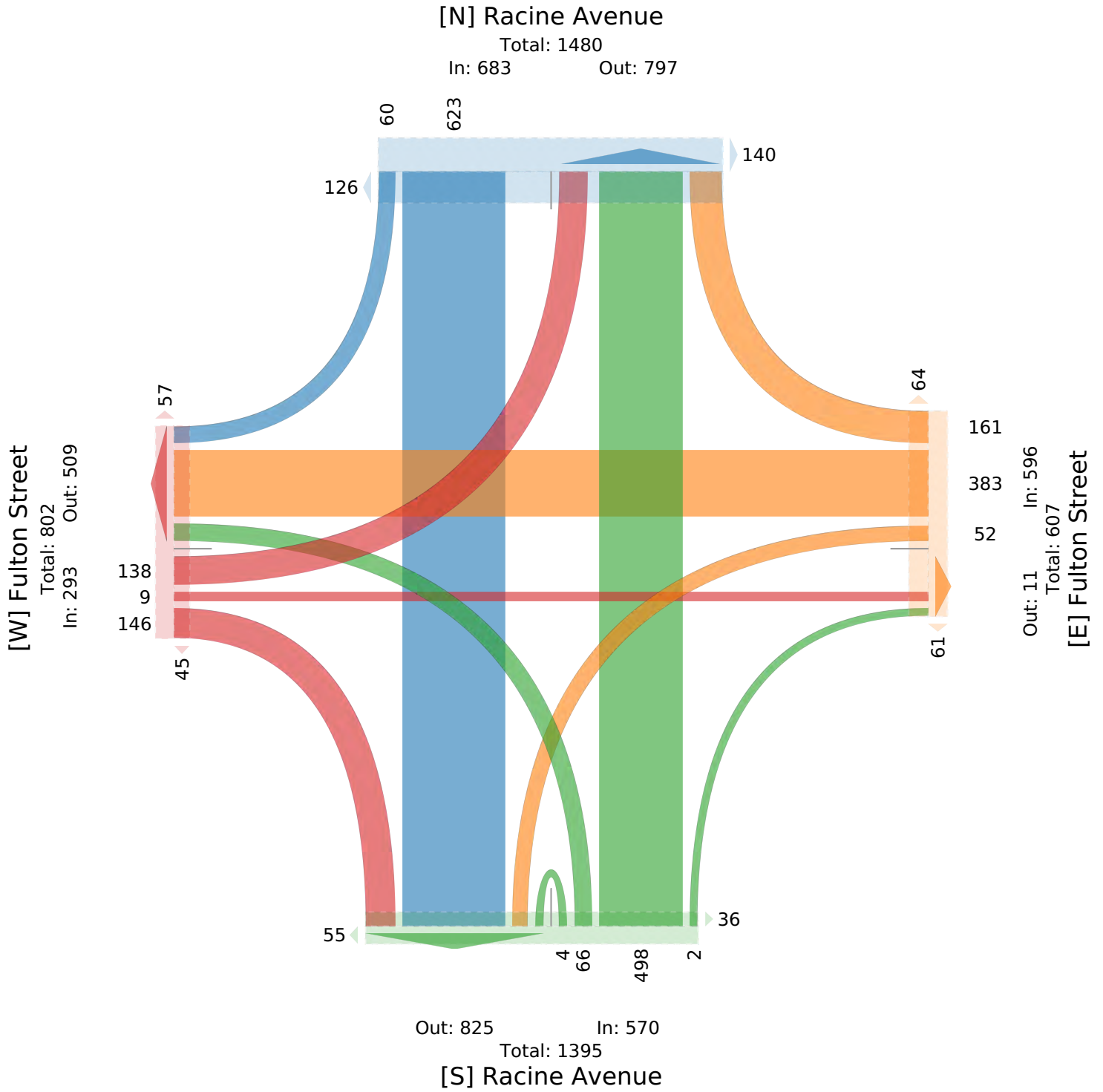

Racine Avenue and Fulton Street TMC - TMC

Wed Mar 20, 2024

PM Peak (Mar 20 2024 4:30PM - 5:30 PM) - Overall Peak Hour

All Classes (Lights, Single-Unit Trucks, Articulated Trucks, Buses, Pedestrians, Bicycles on Road)

All Movements

ID: 1165713, Location: 41.886711, -87.656842



Provided by: Kenig Lindgren O'Hara Aboona, Inc.

9575 W. Higgins Rd., Suite 400, Rosemont, IL, 60018, US

Leg Direction	Racine Avenue Southbound						Fulton Street Westbound						Racine Avenue Northbound						Fulton Street Eastbound						Int
	R	T	L	U	App	Ped*	R	T	L	U	App	Ped*	R	T	L	U	App	Ped*	R	T	L	U	App	Ped*	
2024-03-20 4:30PM	2	32	0	0	34	16	17	40	4	0	61	11	0	45	3	0	48	15	10	1	10	0	21	4	164
4:45PM	4	31	0	0	35	17	20	29	6	0	55	6	0	76	7	0	83	1	7	0	14	0	21	8	194
5:00PM	10	38	0	0	48	32	14	38	3	0	55	15	0	45	8	0	53	8	16	0	12	0	28	8	184
5:15PM	2	40	0	0	42	21	13	38	5	0	56	6	0	29	4	2	35	8	8	0	17	0	25	10	158
Total	18	141	0	0	159	86	64	145	18	0	227	38	0	195	22	2	219	32	41	1	53	0	95	30	700
% Approach	11.3%	88.7%	0%	0%	-	-	28.2%	63.9%	7.9%	0%	-	-	0%	89.0%	10.0%	0.9%	-	-	43.2%	1.1%	55.8%	0%	-	-	-
% Total	2.6%	20.1%	0%	0%	22.7%	-	9.1%	20.7%	2.6%	0%	32.4%	-	0%	27.9%	3.1%	0.3%	31.3%	-	5.9%	0.1%	7.6%	0%	13.6%	-	-
PHF	0.500	0.875	-	-	0.887	-	0.800	0.869	0.750	-	0.906	-	-	0.635	0.688	0.250	0.654	-	0.617	-	0.765	-	0.856	-	0.899
Lights	16	131	0	0	147	-	63	127	16	0	206	-	0	191	20	2	213	-	33	0	50	0	83	-	649
% Lights	88.9%	92.9%	0%	0%	92.5%	-	98.4%	87.6%	88.9%	0%	90.7%	-	0%	97.9%	90.9%	100%	97.3%	-	80.5%	0%	94.3%	0%	87.4%	-	92.7%
Single-Unit Trucks	0	0	0	0	0	-	1	8	1	0	10	-	0	1	0	0	1	-	0	0	2	0	2	-	13
% Single-Unit Trucks	0%	0%	0%	0%	0%	-	1.6%	5.5%	5.6%	0%	4.4%	-	0%	0.5%	0%	0%	0.5%	-	0%	0%	3.8%	0%	2.1%	-	1.9%
Articulated Trucks	0	0	0	0	0	-	0	0	0	0	0	-	0	0	0	0	0	-	0	0	0	0	0	-	0
% Articulated Trucks	0%	0%	0%	0%	0%	-	0%	0%	0%	0%	0%	-	0%	0%	0%	0%	0%	-	0%	0%	0%	0%	0%	-	0%
Buses	0	2	0	0	2	-	0	4	1	0	5	-	0	1	2	0	3	-	4	0	0	0	4	-	14
% Buses	0%	1.4%	0%	0%	1.3%	-	0%	2.8%	5.6%	0%	2.2%	-	0%	0.5%	9.1%	0%	1.4%	-	9.8%	0%	0%	0%	4.2%	-	2.0%
Bicycles on Road	2	8	0	0	10	-	0	6	0	0	6	-	0	2	0	0	2	-	4	1	1	0	6	-	24
% Bicycles on Road	11.1%	5.7%	0%	0%	6.3%	-	0%	4.1%	0%	0%	2.6%	-	0%	1.0%	0%	0%	0.9%	-	9.8%	100%	1.9%	0%	6.3%	-	3.4%
Pedestrians	-	-	-	-	-	86	-	-	-	-	-	38	-	-	-	-	-	32	-	-	-	-	-	30	
% Pedestrians	-	-	-	-	-	100%	-	-	-	-	-	100%	-	-	-	-	-	100%	-	-	-	-	-	100%	-

* Pedestrians and Bicycles on Crosswalk. L: Left, R: Right, T: Thru, U: U-Turn

Racine Avenue and Fulton Street TMC - TMC

Wed Mar 20, 2024

PM Peak (Mar 20 2024 4:30PM - 5:30 PM) - Overall Peak Hour

All Classes (Lights, Single-Unit Trucks, Articulated Trucks, Buses, Pedestrians, Bicycles on Road)

All Movements

ID: 1165713, Location: 41.886711, -87.656842



Provided by: Kenig Lindgren O'Hara Aboona, Inc.

9575 W. Higgins Rd., Suite 400,
Rosemont, IL, 60018, US

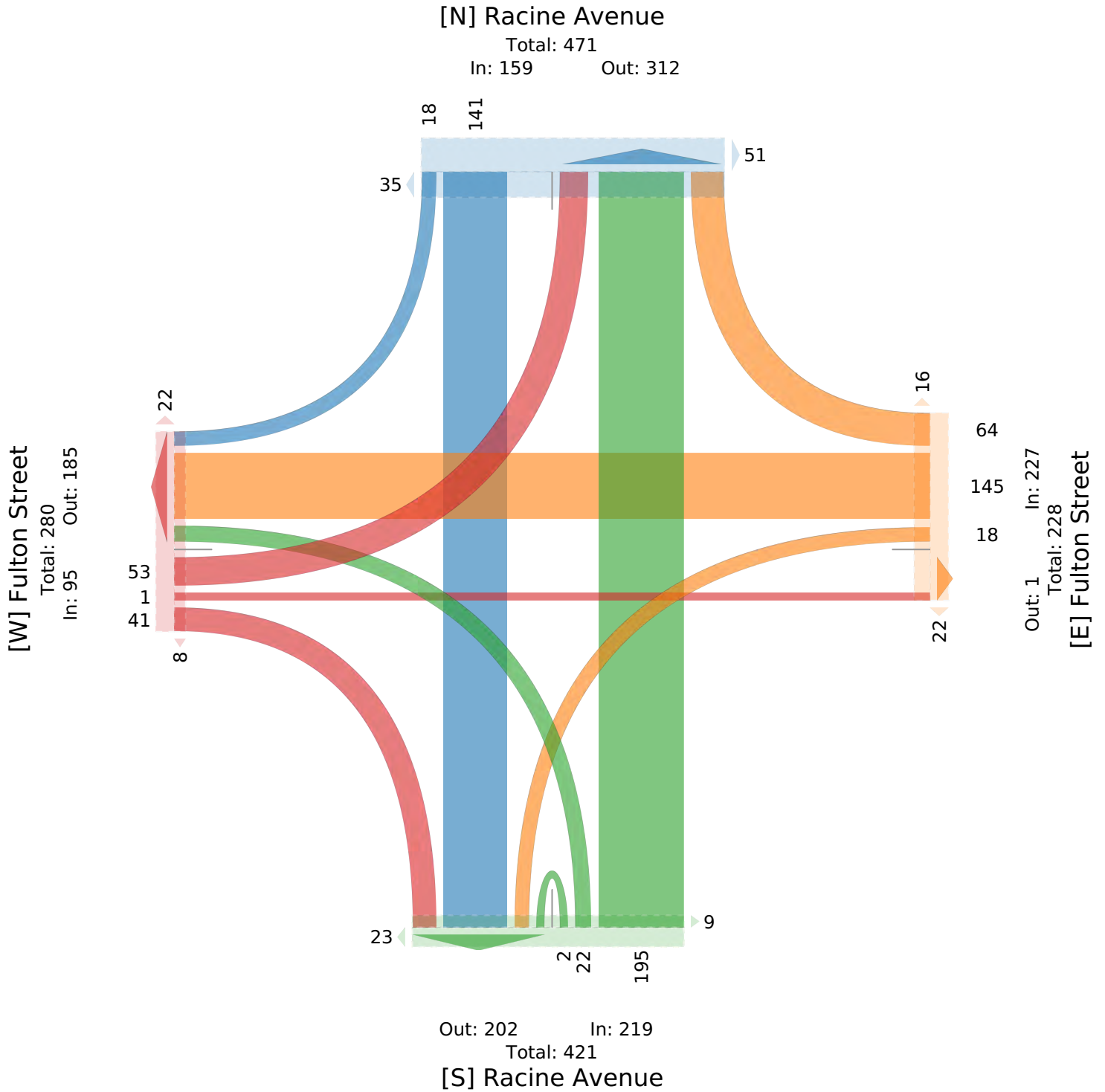

Racine Avenue and Fulton Street TMC - TMC

Thu Mar 21, 2024

AM Peak (Mar 21 2024 7:45AM - 8:45 AM)

All Classes (Lights, Single-Unit Trucks, Articulated Trucks, Buses, Pedestrians, Bicycles on Road)

All Movements

ID: 1165713, Location: 41.886711, -87.656842



Provided by: Kenig Lindgren O'Hara Aboona, Inc.

9575 W. Higgins Rd., Suite 400, Rosemont, IL, 60018, US

Leg Direction	Racine Avenue Southbound						Fulton Street Westbound						Racine Avenue Northbound						Fulton Street Eastbound						Int
	R	T	L	U	App	Ped*	R	T	L	U	App	Ped*	R	T	L	U	App	Ped*	R	T	L	U	App	Ped*	
2024-03-21 7:45AM	1	48	0	0	49	17	4	15	0	0	19	6	0	21	6	0	27	4	8	1	7	0	16	3	111
8:00AM	3	59	0	0	62	15	5	15	5	0	25	5	0	24	3	0	27	4	14	1	5	0	20	5	134
8:15AM	5	39	0	0	44	11	4	16	5	0	25	8	0	18	2	0	20	4	10	1	7	0	18	5	107
8:30AM	2	40	0	0	42	25	6	16	3	0	25	7	1	21	3	0	25	4	13	0	7	0	20	8	112
Total	11	186	0	0	197	68	19	62	13	0	94	26	1	84	14	0	99	16	45	3	26	0	74	21	464
% Approach	5.6%	94.4%	0%	0%	-	-	20.2%	66.0%	13.8%	0%	-	-	1.0%	84.8%	14.1%	0%	-	-	60.8%	4.1%	35.1%	0%	-	-	-
% Total	2.4%	40.1%	0%	0%	42.5%	-	4.1%	13.4%	2.8%	0%	20.3%	-	0.2%	18.1%	3.0%	0%	21.3%	-	9.7%	0.6%	5.6%	0%	15.9%	-	-
PHF	0.750	0.772	-	-	0.770	-	0.750	0.938	0.600	-	0.900	-	-	0.848	0.583	-	0.852	-	0.827	-	0.893	-	0.895	-	0.849
Lights	7	176	0	0	183	-	17	51	10	0	78	-	0	77	11	0	88	-	40	0	24	0	64	-	413
% Lights	63.6%	94.6%	0%	0%	92.9%	-	89.5%	82.3%	76.9%	0%	83.0%	-	0%	91.7%	78.6%	0%	88.9%	-	88.9%	0%	92.3%	0%	86.5%	-	89.0%
Single-Unit Trucks	0	1	0	0	1	-	1	3	1	0	5	-	0	1	1	0	2	-	1	0	0	0	1	-	9
% Single-Unit Trucks	0%	0.5%	0%	0%	0.5%	-	5.3%	4.8%	7.7%	0%	5.3%	-	0%	1.2%	7.1%	0%	2.0%	-	2.2%	0%	0%	0%	1.4%	-	1.9%
Articulated Trucks	1	0	0	0	1	-	0	2	0	0	2	-	0	0	0	0	0	-	0	0	0	0	0	-	3
% Articulated Trucks	9.1%	0%	0%	0%	0.5%	-	0%	3.2%	0%	0%	2.1%	-	0%	0%	0%	0%	0%	-	0%	0%	0%	0%	0%	-	0.6%
Buses	1	2	0	0	3	-	0	4	1	0	5	-	0	0	2	0	2	-	2	0	1	0	3	-	13
% Buses	9.1%	1.1%	0%	0%	1.5%	-	0%	6.5%	7.7%	0%	5.3%	-	0%	0%	14.3%	0%	2.0%	-	4.4%	0%	3.8%	0%	4.1%	-	2.8%
Bicycles on Road	2	7	0	0	9	-	1	2	1	0	4	-	1	6	0	0	7	-	2	3	1	0	6	-	26
% Bicycles on Road	18.2%	3.8%	0%	0%	4.6%	-	5.3%	3.2%	7.7%	0%	4.3%	-	100%	7.1%	0%	0%	7.1%	-	4.4%	100%	3.8%	0%	8.1%	-	5.6%
Pedestrians	-	-	-	-	-	68	-	-	-	-	-	26	-	-	-	-	-	16	-	-	-	-	-	21	-
% Pedestrians	-	-	-	-	-	100%	-	-	-	-	-	100%	-	-	-	-	-	100%	-	-	-	-	-	100%	-

* Pedestrians and Bicycles on Crosswalk. L: Left, R: Right, T: Thru, U: U-Turn

Racine Avenue and Fulton Street TMC - TMC

Thu Mar 21, 2024

AM Peak (Mar 21 2024 7:45AM - 8:45 AM)

All Classes (Lights, Single-Unit Trucks, Articulated Trucks, Buses, Pedestrians, Bicycles on Road)

All Movements

ID: 1165713, Location: 41.886711, -87.656842



Provided by: Kenig Lindgren O'Hara Aboona, Inc.

9575 W. Higgins Rd., Suite 400,
Rosemont, IL, 60018, US

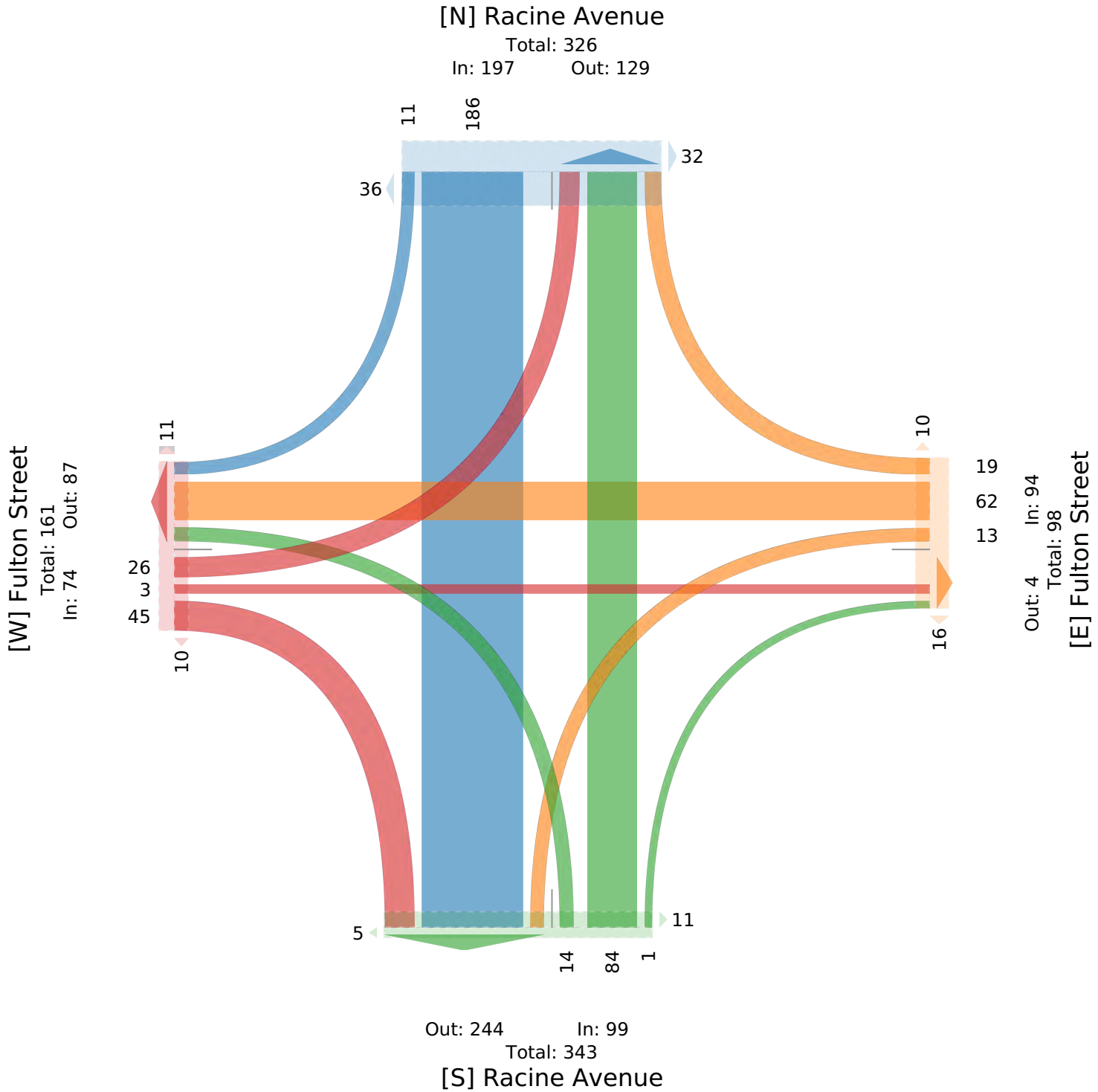

Randolph Street and May Street TMC - TMC

Tue Mar 26, 2024

Full Length (7 AM-9 AM, 4 PM-8 PM)

All Classes (Lights, Single-Unit Trucks, Articulated Trucks, Buses, Pedestrians, Bicycles on Road)

All Movements

ID: 1165697, Location: 41.884212, -87.655585



Provided by: Kenig Lindgren O'Hara Aboona, Inc.
9575 W. Higgins Rd., Suite 400,
Rosemont, IL, 60018, US

Leg Direction	May Street Southbound						Randolph Street Westbound						May Street Northbound						Randolph Street Eastbound						Int
Time	R	T	L	U	App	Ped*	R	T	L	U	App	Ped*	R	T	L	U	App	Ped*	R	T	L	U	App	Ped*	Int
2024-03-26																									
7:00AM	3	9	0	0	12	7	5	35	3	0	43	3	2	7	2	0	11	12	0	11	0	0	11	1	77
7:15AM	2	13	0	0	15	16	6	37	2	1	46	1	2	9	2	0	13	12	0	10	0	0	10	0	84
7:30AM	2	18	2	0	22	8	11	46	1	1	59	5	2	22	3	0	27	17	0	9	0	0	9	0	117
7:45AM	1	13	2	0	16	9	8	44	5	2	59	10	3	11	5	0	19	11	3	11	1	1	16	3	110
Hourly Total	8	53	4	0	65	40	30	162	11	4	207	19	9	49	12	0	70	52	3	41	1	1	46	4	388
8:00AM	2	21	3	0	26	11	8	54	7	1	70	12	7	20	2	0	29	21	1	13	0	1	15	2	140
8:15AM	4	19	1	0	24	14	4	73	5	0	82	3	0	16	4	0	20	27	1	14	0	1	16	3	142
8:30AM	1	11	3	0	15	12	9	44	1	1	55	9	2	5	1	0	8	18	0	15	1	0	16	1	94
8:45AM	7	23	1	0	31	10	5	64	5	1	75	5	0	13	1	0	14	16	1	11	1	0	13	4	133
Hourly Total	14	74	8	0	96	47	26	235	18	3	282	29	9	54	8	0	71	82	3	53	2	2	60	10	509
4:00PM	4	22	1	0	27	14	14	110	5	1	130	7	1	26	1	1	29	23	2	15	0	0	17	3	203
4:15PM	5	13	5	0	23	7	12	138	6	1	157	3	4	27	2	1	34	19	2	11	1	1	15	6	229
4:30PM	7	17	7	0	31	17	20	111	2	2	135	3	3	41	6	0	50	21	1	14	0	0	15	3	231
4:45PM	3	20	6	0	29	18	20	120	4	0	144	7	1	44	4	1	50	30	1	17	1	1	20	3	243
Hourly Total	19	72	19	0	110	56	66	479	17	4	566	20	9	138	13	3	163	93	6	57	2	2	67	15	906
5:00PM	4	16	2	0	22	23	14	108	6	3	131	13	10	33	8	0	51	18	4	16	2	1	23	4	227
5:15PM	3	28	1	0	32	41	10	107	5	1	123	8	6	36	2	0	44	31	1	16	3	1	21	0	220
5:30PM	4	27	2	0	33	13	19	120	6	2	147	7	4	48	3	0	55	27	2	11	2	1	16	2	251
5:45PM	5	19	4	0	28	28	14	102	4	0	120	6	5	35	5	0	45	35	3	19	0	2	24	2	217
Hourly Total	16	90	9	0	115	105	57	437	21	6	521	34	25	152	18	0	195	111	10	62	7	5	84	8	915
6:00PM	2	20	3	0	25	23	15	117	8	0	140	6	5	46	5	0	56	20	1	16	1	1	19	5	240
6:15PM	2	24	1	0	27	22	15	89	1	0	105	2	4	27	5	0	36	26	1	18	1	1	21	3	189
6:30PM	10	26	3	0	39	26	14	133	7	0	154	3	4	23	6	0	33	11	3	18	1	0	22	1	248
6:45PM	3	14	0	0	17	25	18	112	10	0	140	0	3	19	3	0	25	12	3	17	3	2	25	4	207
Hourly Total	17	84	7	0	108	96	62	451	26	0	539	11	16	115	19	0	150	69	8	69	6	4	87	13	884
7:00PM	5	10	1	0	16	24	19	125	6	0	150	4	10	24	5	0	39	13	2	22	1	2	27	2	232
7:15PM	9	15	3	0	27	16	10	94	3	0	107	5	2	24	4	0	30	15	3	19	0	1	23	3	187
7:30PM	7	15	1	0	23	12	13	49	2	0	64	0	8	17	2	0	27	5	1	6	1	1	9	1	123
7:45PM	6	15	1	0	22	18	14	46	3	0	63	4	2	17	1	0	20	11	4	11	1	1	17	0	122
Hourly Total	27	55	6	0	88	70	56	314	14	0	384	13	22	82	12	0	116	44	10	58	3	5	76	6	664
Total	101	428	53	0	582	414	297	2078	107	17	2499	126	90	590	82	3	765	451	40	340	21	19	420	56	4266
% Approach	17.4%	73.5%	9.1%	0%	-	-	11.9%	83.2%	4.3%	0.7%	-	-	11.8%	77.1%	10.7%	0.4%	-	-	9.5%	81.0%	5.0%	4.5%	-	-	-
% Total	2.4%	10.0%	1.2%	0%	13.6%	-	7.0%	48.7%	2.5%	0.4%	58.6%	-	2.1%	13.8%	1.9%	0.1%	17.9%	-	0.9%	8.0%	0.5%	0.4%	9.8%	-	-
Lights	98	415	50	0	563	-	294	1980	104	17	2395	-	86	581	77	3	747	-	38	318	21	19	396	-	4101
% Lights	97.0%	97.0%	94.3%	0%	96.7%	-	99.0%	95.3%	97.2%	100%	95.8%	-	95.6%	98.5%	93.9%	100%	97.6%	-	95.0%	93.5%	100%	100%	94.3%	-	96.1%
Single-Unit Trucks	0	5	3	0	8	-	2	28	2	0	32	-	0	3	0	0	3	-	1	2	0	0	3	-	46
% Single-Unit Trucks	0%	1.2%	5.7%	0%	1.4%	-	0.7%	1.3%	1.9%	0%	1.3%	-	0%	0.5%	0%	0%	0.4%	-	2.5%	0.6%	0%	0%	0.7%	-	1.1%
Articulated Trucks	1	0	0	0	1	-	0	4	0	0	4	-	2	0	0	0	2	-	0	0	0	0	0	-	7
% Articulated Trucks	1.0%	0%	0%	0%	0.2%	-	0%	0.2%	0%	0%	0.2%	-	2.2%	0%	0%	0%	0.3%	-	0%	0%	0%	0%	0%	-	0.2%
Buses	0	2	0	0	2	-	0	14	0	0	14	-	1	1	5	0	7	-	0	0	0	0	0	-	23
% Buses	0%	0.5%	0%	0%	0.3%	-	0%	0.7%	0%	0%	0.6%	-	1.1%	0.2%	6.1%	0%	0.9%	-	0%	0%	0%	0%	0%	-	0.5%
Bicycles on Road	2	6	0	0	8	-	1	52	1	0	54	-	1	5	0	0	6	-	1	20	0	0	21	-	89
% Bicycles on Road	2.0%	1.4%	0%	0%	1.4%	-	0.3%	2.5%	0.9%	0%	2.2%	-	1.1%	0.8%	0%	0%	0.8%	-	2.5%	5.9%	0%	0%	5.0%	-	2.1%
Pedestrians	-	-	-	-	-	414	-	-	-	-	-	126	-	-	-	-	-	451	-	-	-	-	-	56	-
% Pedestrians	-	-	-	-	-	100%	-	-	-	-	-	100%	-	-	-	-	-	100%	-	-	-	-	-	100%	-

* Pedestrians and Bicycles on Crosswalk. L: Left, R: Right, T: Thru, U: U-Turn

Randolph Street and May Street TMC - TMC

Tue Mar 26, 2024

Full Length (7 AM-9 AM, 4 PM-8 PM)

All Classes (Lights, Single-Unit Trucks, Articulated Trucks, Buses, Pedestrians, Bicycles on Road)

All Movements

ID: 1165697, Location: 41.884212, -87.655585



Provided by: Kenig Lindgren O'Hara Aboona, Inc.

9575 W. Higgins Rd., Suite 400,
Rosemont, IL, 60018, US

[N] May Street

Total: 1490

In: 582 Out: 908

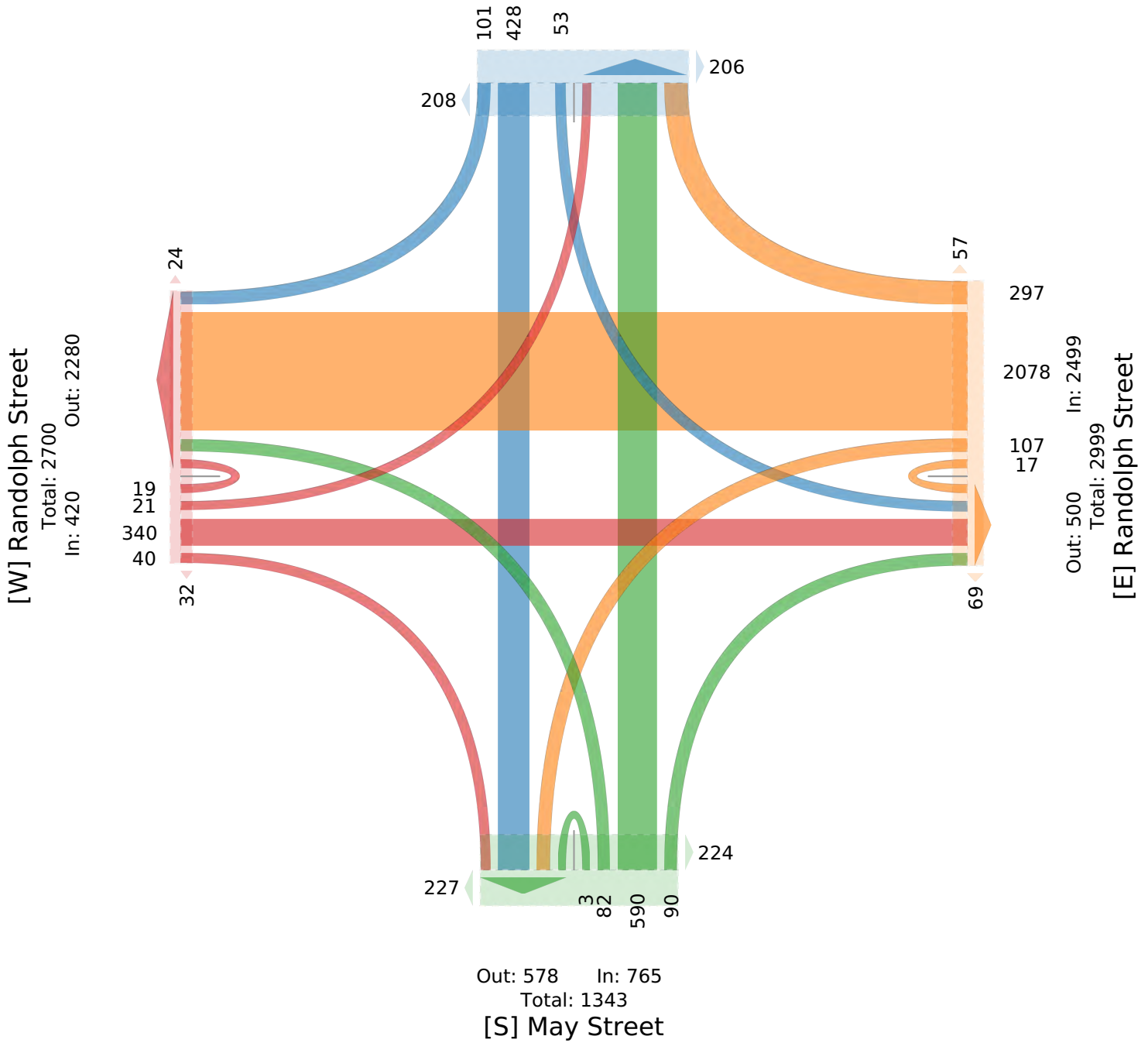

Randolph Street and May Street TMC - TMC

Tue Mar 26, 2024

AM Peak (7:30 AM - 8:30 AM)

All Classes (Lights, Single-Unit Trucks, Articulated Trucks, Buses, Pedestrians, Bicycles on Road)

All Movements

ID: 1165697, Location: 41.884212, -87.655585



Provided by: Kenig Lindgren O'Hara Aboona, Inc.
9575 W. Higgins Rd., Suite 400,
Rosemont, IL, 60018, US

Leg Direction	May Street Southbound						Randolph Street Westbound						May Street Northbound						Randolph Street Eastbound						
Time	R	T	L	U	App	Ped*	R	T	L	U	App	Ped*	R	T	L	U	App	Ped*	R	T	L	U	App	Ped*	Int
2024-03-26																									
7:30AM	2	18	2	0	22	8	11	46	1	1	59	5	2	22	3	0	27	17	0	9	0	0	9	0	117
7:45AM	1	13	2	0	16	9	8	44	5	2	59	10	3	11	5	0	19	11	3	11	1	1	16	3	110
8:00AM	2	21	3	0	26	11	8	54	7	1	70	12	7	20	2	0	29	21	1	13	0	1	15	2	140
8:15AM	4	19	1	0	24	14	4	73	5	0	82	3	0	16	4	0	20	27	1	14	0	1	16	3	142
Total	9	71	8	0	88	42	31	217	18	4	270	30	12	69	14	0	95	76	5	47	1	3	56	8	509
% Approach	10.2%	80.7%	9.1%	0%	-	-	11.5%	80.4%	6.7%	1.5%	-	-	12.6%	72.6%	14.7%	0%	-	-	8.9%	83.9%	1.8%	5.4%	-	-	-
% Total	1.8%	13.9%	1.6%	0%	17.3%	-	6.1%	42.6%	3.5%	0.8%	53.0%	-	2.4%	13.6%	2.8%	0%	18.7%	-	1.0%	9.2%	0.2%	0.6%	11.0%	-	-
PHF	0.563	0.875	0.667	-	0.870	-	0.705	0.743	0.643	0.500	0.824	-	0.429	0.784	0.700	-	0.819	-	0.417	0.714	0.250	0.750	0.766	-	0.883
Lights	9	69	8	0	86	-	31	204	18	4	257	-	10	66	14	0	90	-	5	40	1	3	49	-	482
% Lights	100%	97.2%	100%	0%	97.7%	-	100%	94.0%	100%	100%	95.2%	-	83.3%	95.7%	100%	0%	94.7%	-	100%	85.1%	100%	100%	87.5%	-	94.7%
Single-Unit Trucks	0	1	0	0	1	-	0	4	0	0	4	-	0	2	0	0	2	-	0	0	0	0	0	-	7
% Single-Unit Trucks	0%	1.4%	0%	0%	1.1%	-	0%	1.8%	0%	0%	1.5%	-	0%	2.9%	0%	0%	2.1%	-	0%	0%	0%	0%	0%	-	1.4%
Articulated Trucks	0	0	0	0	0	-	0	1	0	0	1	-	2	0	0	0	2	-	0	0	0	0	0	-	3
% Articulated Trucks	0%	0%	0%	0%	0%	-	0%	0.5%	0%	0%	0.4%	-	16.7%	0%	0%	0%	2.1%	-	0%	0%	0%	0%	0%	-	0.6%
Buses	0	0	0	0	0	-	0	5	0	0	5	-	0	1	0	0	1	-	0	0	0	0	0	-	6
% Buses	0%	0%	0%	0%	0%	-	0%	2.3%	0%	0%	1.9%	-	0%	1.4%	0%	0%	1.1%	-	0%	0%	0%	0%	0%	-	1.2%
Bicycles on Road	0	1	0	0	1	-	0	3	0	0	3	-	0	0	0	0	0	-	0	7	0	0	7	-	11
% Bicycles on Road	0%	1.4%	0%	0%	1.1%	-	0%	1.4%	0%	0%	1.1%	-	0%	0%	0%	0%	0%	-	0%	14.9%	0%	0%	12.5%	-	2.2%
Pedestrians	-	-	-	-	-	42	-	-	-	-	-	30	-	-	-	-	-	76	-	-	-	-	-	8	
% Pedestrians	-	-	-	-	-	100%	-	-	-	-	-	100%	-	-	-	-	-	100%	-	-	-	-	-	100%	

* Pedestrians and Bicycles on Crosswalk. L: Left, R: Right, T: Thru, U: U-Turn

Randolph Street and May Street TMC - TMC

Tue Mar 26, 2024

AM Peak (7:30 AM - 8:30 AM)

All Classes (Lights, Single-Unit Trucks, Articulated Trucks, Buses, Pedestrians, Bicycles on Road)

All Movements

ID: 1165697, Location: 41.884212, -87.655585



Provided by: Kenig Lindgren O'Hara Aboona, Inc.

9575 W. Higgins Rd., Suite 400,
Rosemont, IL, 60018, US

[N] May Street

Total: 189

In: 88 Out: 101

[W] Randolph Street

Total: 299

In: 56 Out: 243

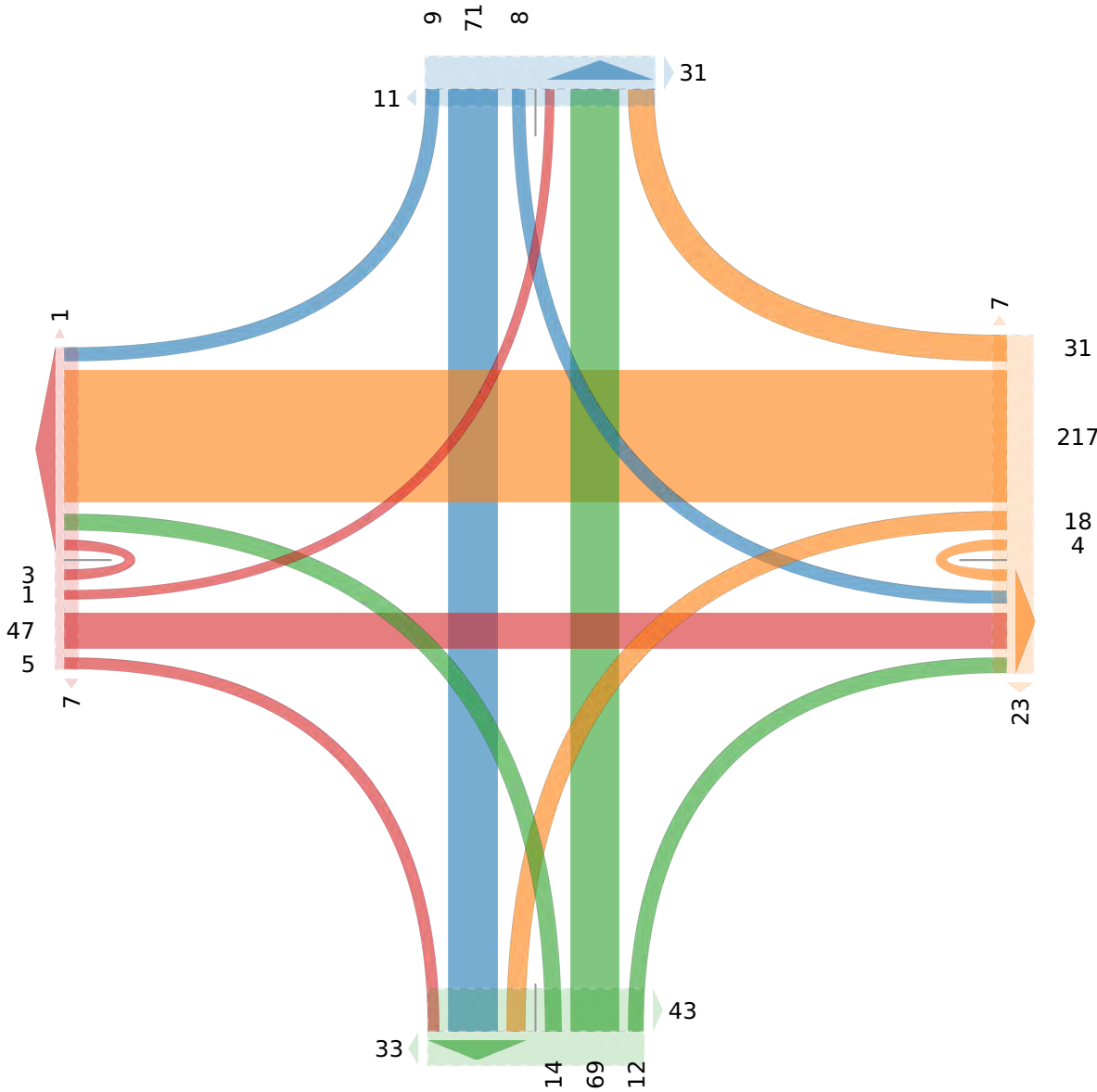

Out: 94 In: 95

Total: 189

[S] May Street

Randolph Street and May Street TMC - TMC

Tue Mar 26, 2024

PM Peak (4:45 PM - 5:45 PM) - Overall Peak Hour

All Classes (Lights, Single-Unit Trucks, Articulated Trucks, Buses, Pedestrians, Bicycles on Road)

All Movements

ID: 1165697, Location: 41.884212, -87.655585



Provided by: Kenig Lindgren O'Hara Aboona, Inc.
9575 W. Higgins Rd., Suite 400,
Rosemont, IL, 60018, US

Leg Direction	May Street Southbound						Randolph Street Westbound						May Street Northbound						Randolph Street Eastbound						Int
	R	T	L	U	App	Ped*	R	T	L	U	App	Ped*	R	T	L	U	App	Ped*	R	T	L	U	App	Ped*	
2024-03-26																									
4:45PM	3	20	6	0	29	18	20	120	4	0	144	7	1	44	4	1	50	30	1	17	1	1	20	3	243
5:00PM	4	16	2	0	22	23	14	108	6	3	131	13	10	33	8	0	51	18	4	16	2	1	23	4	227
5:15PM	3	28	1	0	32	41	10	107	5	1	123	8	6	36	2	0	44	31	1	16	3	1	21	0	220
5:30PM	4	27	2	0	33	13	19	120	6	2	147	7	4	48	3	0	55	27	2	11	2	1	16	2	251
Total	14	91	11	0	116	95	63	455	21	6	545	35	21	161	17	1	200	106	8	60	8	4	80	9	941
% Approach	12.1%	78.4%	9.5%	0%	-	-	11.6%	83.5%	3.9%	1.1%	-	-	10.5%	80.5%	8.5%	0.5%	-	-	10.0%	75.0%	10.0%	5.0%	-	-	-
% Total	1.5%	9.7%	1.2%	0%	12.3%	-	6.7%	48.4%	2.2%	0.6%	57.9%	-	2.2%	17.1%	1.8%	0.1%	21.3%	-	0.9%	6.4%	0.9%	0.4%	8.5%	-	-
PHF	0.875	0.813	0.458	-	0.879	-	0.775	0.932	0.875	0.500	0.918	-	0.525	0.833	0.531	0.250	0.905	-	0.500	0.875	0.667	1.000	0.826	-	0.935
Lights	14	91	11	0	116	-	61	434	21	6	522	-	21	159	17	1	198	-	7	56	8	4	75	-	911
% Lights	100%	100%	100%	0%	100%	-	96.8%	95.4%	100%	100%	95.8%	-	100%	98.8%	100%	100%	99.0%	-	87.5%	93.3%	100%	100%	93.8%	-	96.8%
Single-Unit Trucks	0	0	0	0	0	-	1	4	0	0	5	-	0	1	0	0	1	-	1	0	0	0	1	-	7
% Single-Unit Trucks	0%	0%	0%	0%	0%	-	1.6%	0.9%	0%	0%	0.9%	-	0%	0.6%	0%	0%	0.5%	-	12.5%	0%	0%	0%	1.3%	-	0.7%
Articulated Trucks	0	0	0	0	0	-	0	1	0	0	1	-	0	0	0	0	0	-	0	0	0	0	0	-	1
% Articulated Trucks	0%	0%	0%	0%	0%	-	0%	0.2%	0%	0%	0.2%	-	0%	0%	0%	0%	0%	-	0%	0%	0%	0%	0%	-	0.1%
Buses	0	0	0	0	0	-	0	1	0	0	1	-	0	0	0	0	0	-	0	0	0	0	0	-	1
% Buses	0%	0%	0%	0%	0%	-	0%	0.2%	0%	0%	0.2%	-	0%	0%	0%	0%	0%	-	0%	0%	0%	0%	0%	-	0.1%
Bicycles on Road	0	0	0	0	0	-	1	15	0	0	16	-	0	1	0	0	1	-	0	4	0	0	4	-	21
% Bicycles on Road	0%	0%	0%	0%	0%	-	1.6%	3.3%	0%	0%	2.9%	-	0%	0.6%	0%	0%	0.5%	-	0%	6.7%	0%	0%	5.0%	-	2.2%
Pedestrians	-	-	-	-	-	95	-	-	-	-	-	35	-	-	-	-	-	106	-	-	-	-	-	9	
% Pedestrians	-	-	-	-	-	100%	-	-	-	-	-	100%	-	-	-	-	-	100%	-	-	-	-	-	100%	-

*Pedestrians and Bicycles on Crosswalk. L: Left, R: Right, T: Thru, U: U-Turn

Randolph Street and May Street TMC - TMC

Tue Mar 26, 2024

PM Peak (4:45 PM - 5:45 PM) - Overall Peak Hour

All Classes (Lights, Single-Unit Trucks, Articulated Trucks, Buses, Pedestrians, Bicycles on Road)

All Movements

ID: 1165697, Location: 41.884212, -87.655585



Provided by: Kenig Lindgren O'Hara Aboona, Inc.

9575 W. Higgins Rd., Suite 400,
Rosemont, IL, 60018, US

[N] May Street

Total: 348

In: 116 Out: 232

[W] Randolph Street

Total: 570
In: 80 Out: 490

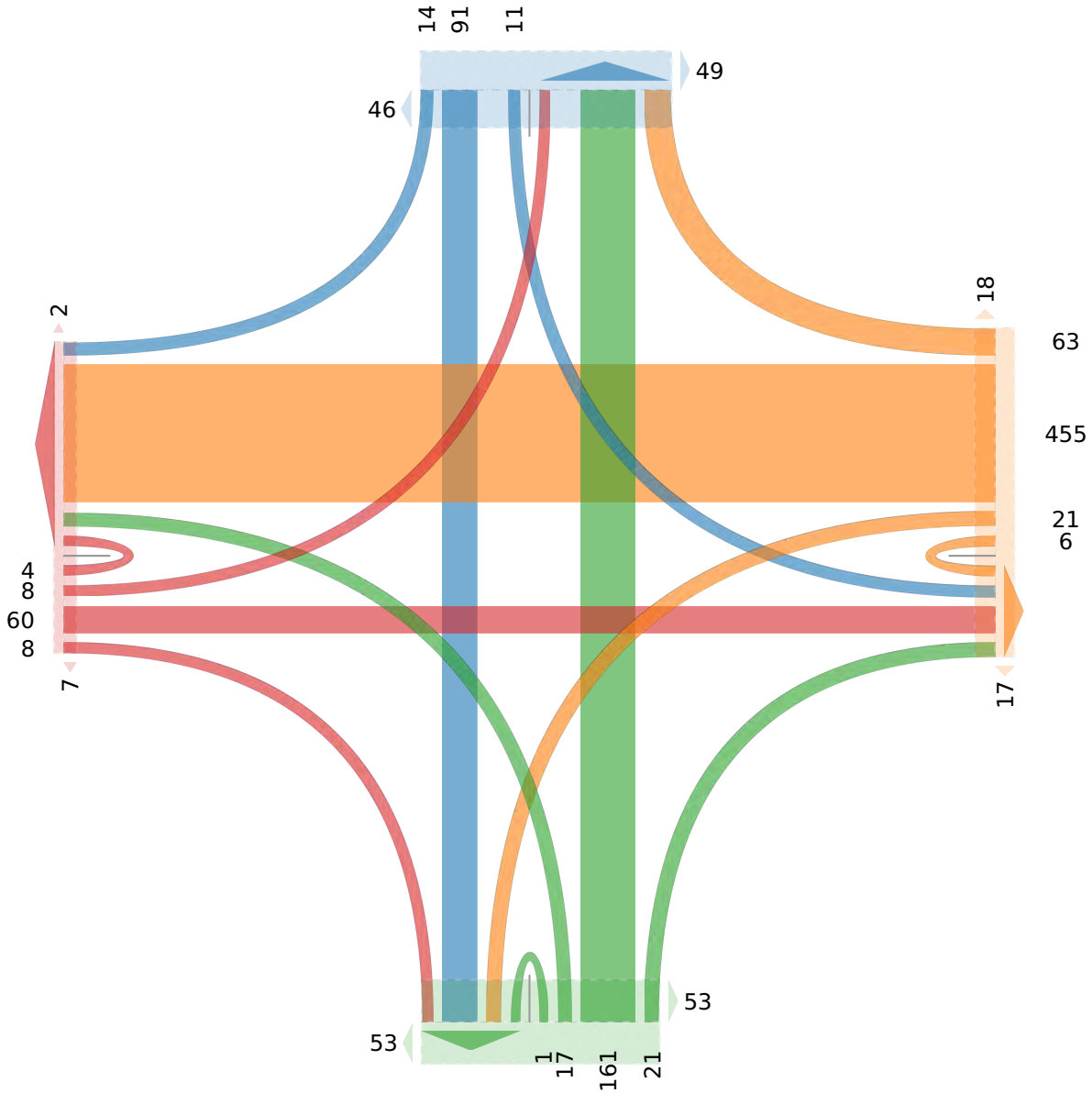

Out: 121 In: 200

Total: 321

[S] May Street

Census Data

Table: ACSDT5Y2021.B08006

Label	Census Tract 2434, Cook County, Illinois		Census Tract 2435, Cook County, Illinois		Census Tract 8330, Cook County, Illinois	
	Estimate	Margin of Error	Estimate	Margin of Error	Estimate	Margin of Error
Total:	2,086	±342	3,245	±340	3,513	±465
Drove alone	915	±264	1,003	±236	910	±235
Carpooled:	73	±52	69	±46	144	±112
Public transportation (excluding taxicab)	431	±148	973	±227	778	±349
Bicycle	64	±58	97	±84	63	±53
Walked	208	±114	522	±176	808	±251
Taxicab, motorcycle, or other means	32	±34	54	±44	104	±122
Worked from home	363	±174	527	±150	706	±248

Number of firms

21 - Mining, quarrying, and oil and gas extraction | All establishments | All establishments | 2022 | +1

Select | Clear Geos | Layer | Year | Basemap | Boundaries | Colors | Identify | Table | Notes | Print | More Tools

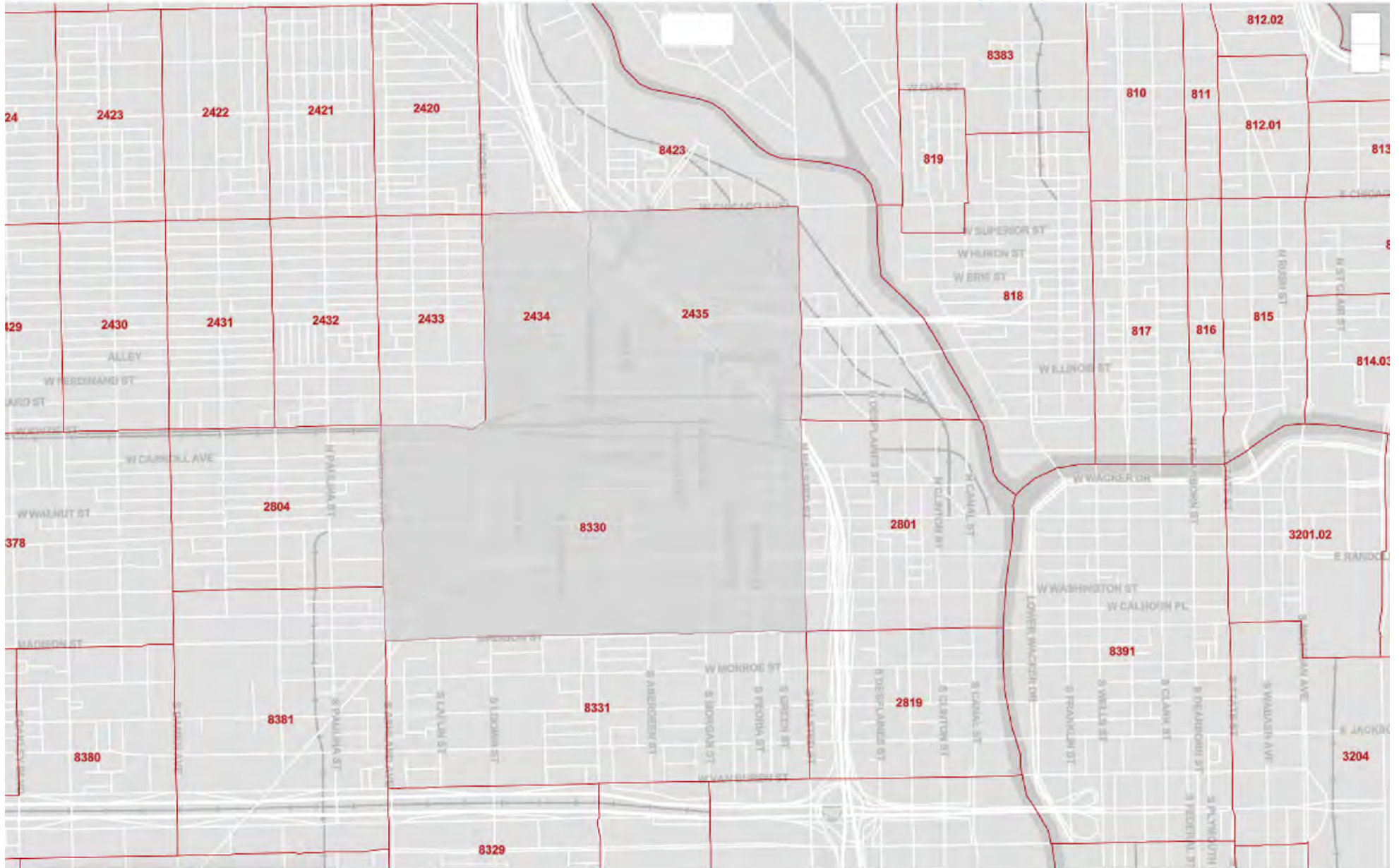

Number by Census Tract	
No Data	3
2022	Geographies: 3

CTA STATION TRANSIT DATA

Station .5 Mile Transit Zone: CTA Blue Line; Grand-Blue	
Year Opened: (1)	Pre-2000
Latitude: (2)	41.891189
Longitude: (2)	-87.647578
Workers 16 years and over: Total: (3)	7,098
Percent who take public transportation: (4)	23.95
Percent who take public transportation, bicycle or walk: (5)	48.85
Public transportation: (6)	1,700
Walked: (7)	1,725
Bicycle: (8)	42.43
Car; truck; or van: (9)	2,796
Motorcycle: (10)	0.00
Other means: (11)	65.73
Worked at home: (12)	463

Station .25 Mile Transit Zone: CTA Pink Line, Green Line; Ashland-Lake	
Year Opened: (1)	Pre-2000
Latitude: (2)	41.885269
Longitude: (2)	-87.666969
Workers 16 years and over: Total: (3)	573
Percent who take public transportation: (4)	15.63
Percent who take public transportation, bicycle or walk: (5)	34.27
Public transportation: (6)	89.62
Walked: (7)	102
Bicycle: (8)	4.50
Car; truck; or van: (9)	303
Motorcycle: (10)	0.00
Other means: (11)	0.00
Worked at home: (12)	73.68

- 1 The year in which this station opened. This value is intended to inform the analysis of available statistics, and therefore all stations open prior to 2000 report as "Pre-2000", the year of the earliest available statistic.
- 2 Station location, current as of October 1, 2023. Station locations are updated (as necessary) on a quarterly basis which may result in changes in aggregated data.
- 3 American Community Survey 2005-2009 5-Year Estimates b08301_001 aggregated from Census 2009 Block Groups
- 4 American Community Survey 2005-2009 5-Year Estimates (b08301_010) / (b08301_001) aggregated from Census 2009 Block Groups

- 5 American Community Survey 2005-2009 5-Year Estimates $(b08301_010 + b08301_018 + b08301_019) / (b08301_001)$ aggregated from Census 2009 Block Groups
- 6 American Community Survey 2005-2009 5-Year Estimates b08301_010 aggregated from Census 2009 Block Groups
- 7 American Community Survey 2005-2009 5-Year Estimates b08301_019 aggregated from Census 2009 Block Groups
- 8 American Community Survey 2005-2009 5-Year Estimates b08301_018 aggregated from Census 2009 Block Groups
- 9 American Community Survey 2005-2009 5-Year Estimates b08301_002 aggregated from Census 2009 Block Groups
- 10 American Community Survey 2005-2009 5-Year Estimates b08301_017 aggregated from Census 2009 Block Groups
- 11 American Community Survey 2005-2009 5-Year Estimates b08301_020 aggregated from Census 2009 Block Groups
- 12 American Community Survey 2005-2009 5-Year Estimates b08301_021 aggregated from Census 2009 Block Groups

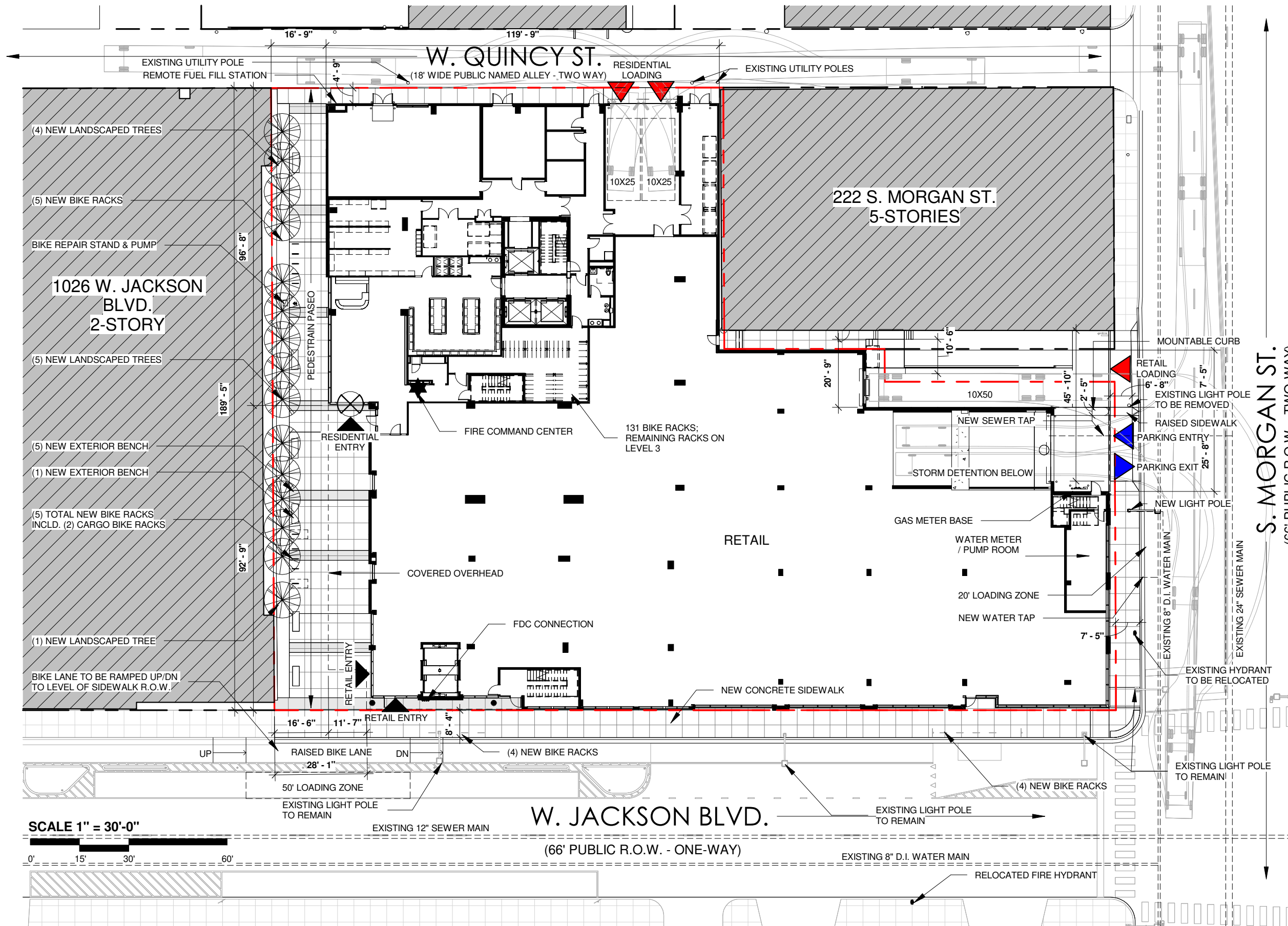

PARKING TOTALS	
LEVEL 1	0 STALLS
LEVEL 2	77 STALLS (RETAIL)
LEVEL 3	86 STALLS (RESIDENTIAL)
163 TOTAL PARKING STALLS	
6 ADA STALLS TOTAL	
EVSE REQUIREMENTS	
LEVEL 2	16 EVSE-READY STALLS
LEVEL 3	83 EVSE-READY STALLS
BICYCLE PARKING	
380 STALLS REQUIRED	
LEVEL 1	131 BIKE STALLS
LEVEL 2	0 BIKE STALLS
LEVEL 3	249 BIKE STALLS

NOTE: EV-ELECTRICAL VEHICLE EQUIPMENT REQUIRED PER SECTION 14E-6-625, CHICAGO ORDINANCE, AS OF NOV. 1, 2023.

NOTE: ANY AND ALL ALLEY RECONSTRUCTION REQUIRED SHALL FOLLOW CDOT GREEN ALLEY PROGRAM STANDARDS.

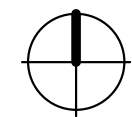
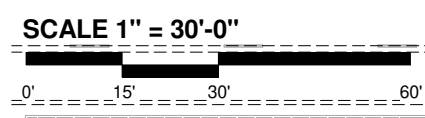
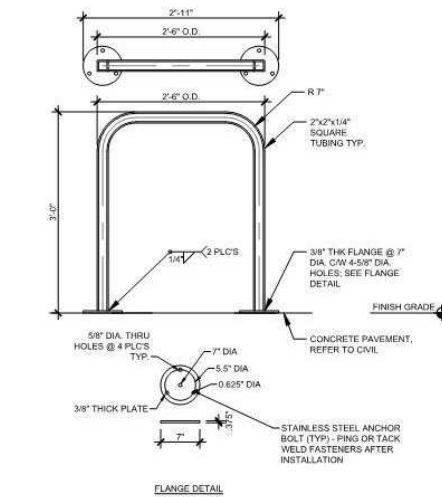

NOTE: ALL CHANGES IMPACTING PARKING RESTRICTIONS, LOADING/STANDING ZONES, OR ANYTHING THAT REQUIRES ORDINANCE INTRODUCTION MUST BE COORDINATED WITH THE WARD OFFICE.

CITY OF CHICAGO
Department of Transportation
Plan Review Committee Approval*
Site Plan Over-sized Driveway
Other:
Signed: *[Signature]*
Date: 7/12/2024
Project Title: 1016 W. Jackson Blvd.
*Subject to acceptable construction drawings, addressing and other program approvals.
Non-transferable, revocable if modified.

APPLICANT: 1016 W JACKSON LLC
ADDRESS: 1000-24 WEST JACKSON BOULEVARD
228-38 SOUTH MORGAN STREET
1015-27 WEST ADAMS STREET
INTRODUCTION: MARCH 20, 2024
PLAN COMMISSION: JUNE 18, 2024